

the CALIFORNIA

MV

Collector

NEWSLETTER



EDITOR: DAVE BALL *

2017

* VOL. XL, NUMBER 11



VETERANS DAY

IN THIS TIME
SINCE THE DEATHS OF THE PEOPLE
FOR WHOM HE SAVED THE UNION
THE MEMORY OF ABRAHAM LINCOLN
IS ENSHRINED FOREVER

November 11, 2017



"To care for him who shall have borne the battle..."

ABRAHAM LINCOLN



www.va.gov



CONTENTS

| | |
|--|---------------|
| UPCOMING EVENTS | 4, 5 |
| MVCC STAFF | 3,6, |
| CLASSIFIEDS | 14, 15 |
| MVCC MEMBERSHIP APPLICATION | 18 |

Wagon Mistress Report Jo-Ann Lesser 408.238.8277

TOWER PARK RESORT 2018

The MVCC will be returning to Jellystone Tower Park Resort in 2018. The dates for this event are **September 16-23, 2018**. If you were assigned a site and attended in September 2017 your name and site number have already been sent to Tower Park reservations and they are awaiting your deposit for 2018. **209.369.1041** There is a 4 day minimum stay required and deposits are 25% due prior to **February 1st, 2018** with a second installment of 25% by **July 1st, 2018**.

The remaining balance is due upon arrival. If you did not attend in 2017 and need a site please let me know. Any sites showing no deposit after July 1st, 2018 will be offered to members and non-members that wish to attend.

KOA PETALUMA 2018

Now that the dust has settled on our September 2017 event at Tower Park, it is time to start ramping up for Camp Petaluma **April 23-28, 2018**. This is a 4 day event however, if you would like to be an earlybird just let KOA know your preferred arrival date.

There have been quite few requests for site moves and new reservations. Some folks that have been assigned sites currently have **NO** deposits on them. Please call KOA at **707.763.1492** and get a deposit on your site! When contacting KOA please confirm your arrival date. Sites with no deposits by **February 1st, 2018** will be offered to members and non-members that wish to attend. Any questions or concerns please don't hesitate to give me a call.

Jo-Ann

AT THE FRONT



Dave Ball, MVCC President
(408) 805-0065
vought@msn.com

Hello Everyone:

I hope you all got to attend your local Veteran's Day parade and drive your military vehicles. A big "thank you for your service" goes out to all of our veterans.

I am going to put on my editors hat for a moment. If you have pictures of Veteran's Day festivities, please email them to me with a short description of what is in the picture, where it was taken, and the names of the people pictured. You can number the pictures in the description and write a short explanation if you like. I will get them in the next couple of newsletters.

November and December are known as the Holidays. I know I speak for the entire MVCC Board in wishing each and every one of you a safe and happy holiday. I hope everyone gets some time to relax and have fun with their family and friends.

One final note, dues are due in January. February 2018 is the newsletter cut-off date. Please check the label on the envelope that this newsletter came in. If it says "2017," then please use the form on the back of the newsletter to renew; otherwise, No. 12 will be your last newsletter.

Let's all try and make Johnny's job a little easier. It is hard work keeping up and tracking members down. Please don't wait until Camp Petaluma in April to pay your dues. You will miss lots of important info about events such as Camp Petaluma. Speaking of Camp Petaluma, better get your deposits down ASAP as requests for sites are coming in and advertising has started. Remember please share sites with friends when possible.

"Keep 'em Rolling, Floating, and Flying"
Stay safe,

Dave Ball

**JAY'S
WWII JEEPS**

Specializing in vintage
WWII Willys MB/Ford GPW
vehicles and parts

1-844-WW2-JEEP

Jay Hinton | Napa, California USA | 1-844-992-5337 | jay@jaysww2jeeps.com

CLASSIC MILITARY AUTOMOTIVE

A division of
CMA North Bay

Shop: 1385-B CASS RD, SANTA ROSA, CA 95406
Mailing: PO BOX 6167, SANTA ROSA, CA 95406

Phone: 707-542-4353
Fax: 707-544-8230

Email: gpajeep@yahoo.com
www.classicmilitaryautomotive.com

Ask for
TERRY O'CONNOR

1941 to 1954 AWD military vehicle sales, restorations & repairs

MVCC FRONT OFFICE

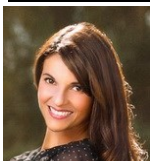

Christina Verissimo, Treasurer
(209) 918-0388
crstna_vrsmo@yahoo.com



John Verissimo, Secretary
(209) 918-0488
istanbull@sbcglobal.net

UPCOMING EVENTS

April 24-29, 2018 Spring Meet Petaluma KOA.

No vendor fee except camping fee.

Contact: MVCC Wagon Master

Jo-Ann Lesser; (408) 238- 8277

mamalesser@yahoo.com

September 2018: Camp Gridley

Butte County Fairgrounds, Hosted by the NRG

www.northernrecongroup.org

September 18-23, 2018 Fall Camp Delta

Second largest annual Military Vehicle gathering and swap meet in the West.

Location Tower Park resort Jelly Stone Park

For reservations, please call Joann lesser

408-238-8277

www.mvccnews.net

Please send in your 2018 events for the MVCC Newsletter Calendar.

Eagle Field FLY

IN

COMING BACK IN

JUNE 2018!!!

GET READY for a BIGGER and BETTER Eagle Field Fly In, Dinner and Dance!!

Get ready to dance to a BIG BAND, eat great food, and wander the runway and hanger to see beautiful War Birds, Military Vehicles and People dressed in period attire.

Stay tuned for more information coming soon!



ANDREW MOJARRAS
JR. VICE COMMANDER
2017-2018

P.O. Box 1872
TURLOCK, CA 95380

(209) 712-8572
andrewcadav@gmail.com
www.davcal.org

FULFILLING OUR PROMISES

TO THE MEN AND WOMEN WHO SERVED

If you have any questions or have information regarding a meet or activity in your area, contact your regional vice president or any of the officers to let them know. Be sure to visit our website for any last minute activities or changes to activities/events. Please submit information regarding upcoming activities to the newsletter editor at least two months before the scheduled event. All articles must be submitted to the newsletter editor by the 15th of each month.



From the “Southern Boys and girls”. MVCC members, Erik and Mary Terberg (pictured) along with John Bodnar and Julie Antonelli joined the gang from the Inland Empire Military Museum to participate in the 17th annual San Bernardino Veterans Day Parade. We had 7 MVs following right behind the color guard and the Grand Marshall. The next day, the attached picture of us was on the front page of the local paper. The parade ended at a park where there was recognition of our Veterans by the local politicians and the public. Our MVs were quite a hit with the crowds. Several car clubs also showed up with their shiny, colorful vehicles but O.D. green is much more popular.

Erik Terberg



MVCC NEWS STAFF



MVCC Editor Dave Ball

(408) 805-0065 vought@msn.com

Please submit all contributions for publication in the newsletter by email to the editor by the 15 of the month.



Webmaster Sean Nichols

Jetnoise400@hotmail.com

www.mvccnews.net

(775)-424-3813

MVCC STAFF



Andy Shyers East Bay VP
Divisions 510, 925
510-832-4322
mvcc510925@gmail.com



Scott Rohrs, North. Bay West VP
Divisions 707 & 415 west
415-259-8177
recon3rdid@yahoo.com



Dave Porter, Northern Region VP
Divisions 530 & 916
dnporter56@comcast.net
530-677-5115



Jack Valenti, Central Coast VP
Divisions 831, 805 408 south
LRDG@PRODIGY.NET
831-595-3487



Kim Sievert, South Bay VP
(408) 253-9469
vaudevillian@msn.com
Divisions 408, 669 North 650



Don Gomes, Central Valley VP
Divisions 209, 559, 661, 760
(209) 765-1273
caddymanwestside@yahoo.com



Sonny Hanson, No. Bay, East VP
(707) 552-6918 Div. 707, 415
sonnyhanson@comcast.net



John Neuenburg in his SAS Jeep getting ready to go on Patrol.

Camp Delta 2017

Craig Clifton



I took these pictures at the Danville Veterans Hall. Battlefield cross.
"All Gave Some- Some Gave All"

Ed.



Handwritten notes:
The back of the picture is just as interesting as the front.
+
SF385444

THE NEW
Division of NE
MISSION ST.
PICTURE IS SOLD TO
ATION ONLY AND MUST
FD OR USED FOR AD
UT WRITTEN PERMISS
CEPTING THIS PICTUR
ACME HARMLESS FRO
RISING BY REASON OF
BLICATION OF THIS PI

SF385444 (SAN FRANCISCO BUREAU)

HUGE SURPLUS DETERIORATES AT OGDEN

OGDEN, UTAH-MAJ. GEN. EVERETT S. HUGHES, ARMY CHIEF OF ORDNANCE SHOCKED BY HIS VIEW OF 20,000 ARMY VEHICLES SLOWLY RUSTING AWAY, AT OGDEN, UTAH, STATED THAT HE INTENDS TO SUGGEST TO WAR DEPARTMENT THAT RESERVE EQUIPMENT REQUIREMENTS BE REVIEWED AND MATERIAL THAT CAN BE DISPENSED WITH, EITHER SOLD OR JUNKED. HE INDICATED THAT BECAUSE OF LACK OF FUNDS, PERSONNEL AND FACILITIES, ORDNANCE DEPARTMENT IS UNABLE TO GIVE PROPER PROTECTION AND MAINTENANCE TO HUGE NUMBERS OF ALL TYPES OF VEHICLES, INCLUDING THESE SEVERAL THOUSAND JEEPS, TRUCKS, SOME TANKS, COMBAT CARS AND OTHER TYPES OF MOBILE ARMY EQUIPMENT.

BUREAU T CREDIT LINE (ACME) 1/24/47

856166
771758

Page 8-9 Utah military vehicle dump. Sometimes the back of the picture is just as interesting as the front.

Military Vehicle Collectors of California Merchandise



The 2017 MVCC Petaluma Meet Tshirt.

"Olive Drab"

This is a limited run Military Vehicle Event Tshirt, once they are gone they are gone! Sizes S,M,L,XL, XXL

Email or text for sizes still available!

\$20.00

The 2017 MVCC Petaluma Meet Tshirt

"Kaki" color...

\$20,00

These are limited, check for sizes



Limited Run 40th Anniversary MVCC Patch. This is a 4 inch patch, looks great, I bought 2 myself!

\$7.00 each



Limited Run 25th Anniversary MVCC Patch

This is a 4 inch patch, looks Awesome!

\$4.00 each



MVCC Patch

3 1/2 tall

\$3.00 each

This MVCC magnate is perfect for those who aren't sure they want a perminate sticker on their cars or military vehicles!



MVCC magnate

3 inch tall

\$2.00 each

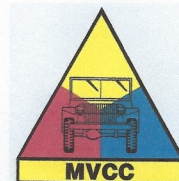

MVCC sticker

3 inch tall

\$2.00 each

MVCC Stickers are a GREAT WAY to show everyone you are a MVCC Member, put them on your military vehicles or your automobiles!



MVCC sticker

2 inch tall

\$1.00

These little stickers are great for car windows, tool boxes, gas cans etc...

For availability email istanbull@sbcglobal.net or text (209)918-0488

Mail payment to Christina Verissimo
Treasure MVCC
850 Elm Ave
Gustine, Ca. 95322

Shipping; Give us your zip code and we will give you a shipping cost.

We don't have a Quartermaster yet so Don Gomes and Myself (Johnny Verissimo) are filling in as best we can, thank you for your patients...!

The MVCC Antenna Guidon/Pennant is still available \$25.00. These are great for your flag pole or your military vehicle antenna!



MVCC and FVJG members attended the Veterans Day Parade in Auburn on 11 November. Grand Marshall Dustin Byers, a US Army Veteran of Afghanistan, rode in Ben Hovis' Jeep at the head of the parade. Other Jeeps were driven by Doug O'Neil, Pat Walker, Randy Payne, Tim Buescher, and Dave Porter. Tom Gunther drove his halftrack. Pictures from Ben Hovis.

MVCC BUSINESS MEMBERS

Ron Fitzpatrick
JEEP PARTS



1022 Newland Road
 Central Point, Oregon 97502

sales: 800-600-5337
 tech: 541-830-3030
 fax: 541-830-5337

www.rfjp.com www.g503.com/parts

RON FITZPATRICK
 sales@g503.com
 ron@g503.com

★ ★ ★ ★ ★ ★ ★ ★

Dc Truck parts 541-772-8992

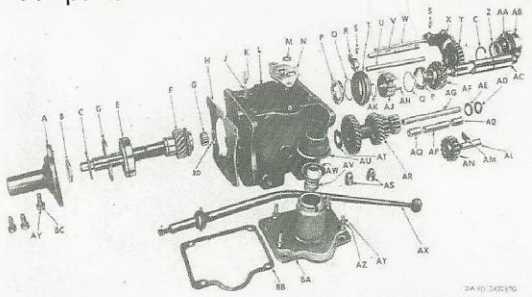

Dave Cirillo
 dctruckparts@msn.com

EXPEDITION IMPORTS
Get Out of the Ordinary!

Scott Ingham
 President

scott@expedition-imports.com
 www.mpttires.com
 www.expedition-imports.com

1335 Lemon Street
 Vallejo, CA 94590
 Tel 707.643.6757
 Cell 707.319.7252
 Fax 707.643.2998

Ray Del Pino  DMV License #VV17807

ANTIQUE • CLASSIC • MODERN
VIN NUMBER VERIFICATION
 AT YOUR LOCATION IN SOUTHERN CA
 TRUCKS, TRAILERS, SPECIAL MOBILE EQUIPMENT
 MOTOR HOMES, AND CARS
 DMV RUNNER SERVICE
 CLASS C DRIVEAWAY - GETAWAY DRIVER
 15708 E. Grovecenter St. • Covina, CA 91722
 Cell: (626) 391-2167 • Home: (626) 814-2196

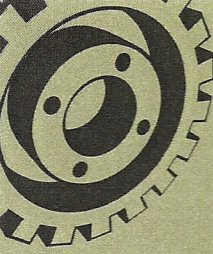

DOWNTOWN TRUCK PARTS

NORMAN GORELICK

20830 KINGSBURY ST
 CHATSWORTH CA 91311

1-818-709-3676
 MACK6X6@AOL.COM



CARSON PLAINS SURPLUS & STORAGE
 Military Surplus, Military Vehicles, Storage, Firewood
JON BIRCHEFF
 Owner



P.O. Box 1289
 70 S. Rainbow Dr
 Dayton, NV 89403
 Cell: 775-246-7186
 Fax: 775-241-7142
 jon.cpsands@gmail.com
 www.cpsands.com

Smith Chevrolet Cadillac, Inc.
"Where service comes first since 1926"
 1601 Auto Mall Drive
 Turlock, CA 95380





Lee C. Smith
 Owner
 (209) 632-3946
 (209) 988-8832 Cell
 (209) 667-7157 Fax
 leesmith@SmithChevroletCadillac.com
 smithchevroletcadillac.com

Find us on facebook.

Visit Online Store @ www.rfjp.com

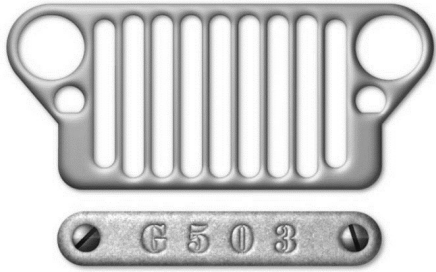
Ron Fitzpatrick



JEEP PARTS

SEE OUR WEBSITE @ www.rfjp.com



(541) 830-3030 (local) * (541) 830-3031 (tech)
sales@g503.com (541) 830-5337 (fax)
M-F 8 a.m. till 5 p.m. West Coast

800-600-JEEP (5337)

New not Rebuilt

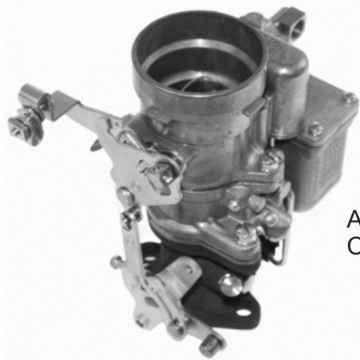

A1223 Carter WO Carburetor \$310



A8180 - LN Speedometer w/ trip odometer \$100 MB or GPW

Note: These have 1 mph incremented dials with the correct luminous paint on needles and the 10 mph and 20 mph markers

A8180 - SN Speedometer w/ trip odometer \$100 MB or GPW



Available markings
GPW \mathcal{F} GPW8505
or
MB 637052



639992 Water Pump MB or GPW \$90



A8323 Fuel Pump w/ PrimerLever \$60

A847 or A838 Tie Rod End Kits \$15

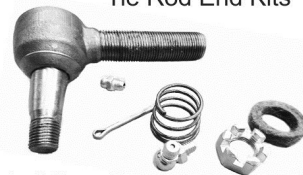

A1339 Hub Puller \$15

GPW w/ script \mathcal{F} available

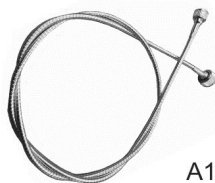

A1267 Speedometer Cable With metal Housing \$15

Available markings
GPW \mathcal{F}
or
MB TP

Each Kit includes cup, spring felt washer, cotter pin, castle nut and 2 zerk fittings

FREE SHIPPING*

Online Orders Only thru August 31st, 2017

* restrictions apply: no phone orders, continental U.S. orders only, \$200 minimum order, oversized and freight orders excluded

CLASSIFIEDS

For Sale: 1943 GTBS with crane and winches and both are frozen and engine is civilian flat head six .. also have parts from other GTBS's for sale ..asking \$2200 OBO For truck & crane Don . 209-765-1273 or email for me photos caddymanwestside@yahoo.com 11-17

FOR SALE: 1967 M725 Kaiser Jeep ambulance for parts or restore. Little rust, most pieces there and in good shape. Top was chopped to make it more of a pickup. Was used on a Christmas tree farm to haul families and the trees. Email for pictures. \$1000 or may trade for small, WWII items for display in the Motor Pool Museum at my house.
Lee Edwards whenlde@aol.com 2-18

For Sale: 1942 MBT very little rust tub in great shape . Title in hand and currently tagged also have all parts to put back to original . Has tail gate but repro rear panel to Replace comes with trailer \$1399 Don 209-765-1273 11-17

For Sale: 1968 M715 Kaiser Jeep US Army 725 25th MT. Truck has no rot restore or drive as is with original paint and markings. Has Chevy V8 professional install and 12 volt. \$4000 or best offer.
Dave 408-805-0065 1-18

For Sale: M416 1/4 ton trailer original good condition need lights. Has not been cut or torched. Bed and fenders in good shape drains work. No rot. \$1100 Dave 408-805-0065 1-18

For Sale: 1977 Dodge M880: 4 wheel drive, rebuilt larger dodge engine w/ 4 barrel carb, upgraded muffler system, heavy duty truck tires, shock absorbers, over load springs and sway bar, electric winch, CUCV grill guard, power steering, spot light, black out lights, siren, roof rack, mounted tow bar, reupholstered seats, antenna mount, and power supply for PRC 25/77 radio. This truck is in excellent condition. It has just been serviced and has a new CA smog certificate. A comfortable military vehicle with lots of power. Call Chuck Billings 415 717-9904 or e-mail drcrbillings @comcast.net. 11-17

For Sale: 1952 Willys M38A1 Jeep has many of the original parts. Seats front and rear need pads and canvas. Still 24 Volt. Engine ran a year ago but rough. Missing top bows and batteries. Has tow bar and is towable. \$4000 or best offer.
Pictures below Dave 408-805-0065 12-17



Classified Ads are free for military vehicle related items and kit for MVCC members. Your ad will run for three issues. Your editor will only except ads in writing. Please submit your ad by email: vought@msn.com or by post to: MVCC Editor: 18549 Paseo Tierra St. Saratoga Ca. 95070. Please print clearly and include contact info and price. Please submit ads by the 15th of the month. If you want to make changes to your ad including extending or cancelling your ad, you must notify your editor in writing. The MVCC is not responsible for omission's or Incorrect wording and or spelling. The MVCC reserves the right to edit ad copy for space. Please send payment for paid ads to: LK Viola, Email: sec-treasurer@mvcnews.net

Ad prices: full page \$45 Half page \$35 Quarter Page \$20 Business Card \$5 per issue

CLASSIFIEDS

For Sale: 1952 M-38 A-1 Willy Jeep, lots of new parts: fuel tank cleaned, new fuel pump, new carb, new electronic distributor, new spark plugs and wires, new muffler, new radiator hoses, new antifreeze, oil and filter change, new tow bar, new seat covers, has back seat. Comes with extra parts, and tires. Runs very good, has Ca. historical plates that are current. Serve in Korea war, then surplus to Universal Studios, was on Mash TV series: movie prop!! 12 Volt conversion, with alternator, New battery, solar charger, Needs wiring harness installed, comes with painless wiring harness. Might need steering box rebuilt? Have receipts on all new parts, that were put on. Health and family emergency forces sale of this jeep. Have over \$4,000 invested new parts. Located in Murrieta, CA. 92562. \$6,500 Firm Call Jim 760-214-0908 11-17

For Sale: 900x20 ND Military Tires \$50ea
USA BF Goodrich take offs tubes and flaps inside
M-series Tow Bar, Unused, CARC, complete, \$300
sfmoviecars@gmail.com
Joe Hunter
Pictures below
1-18



Wanted: Parts for RT-524, Radio Remotes (2), Radio Control C-2299/VRC, 524-Radio Control Cable CX-4723U, Antenna Wire CG-3855/VRC. POC- Sonny Hanson 707-552-6918 or Bob Taylor 707-953-7242 11-17

Wanted: US navy Capt. Gig, 36 ft. leads wanted. WW I Navy Dress blue and White uniforms. E M or Officers. Any Kalvanator Appliance..... Refrigerator, Washer, Dryer etc. any cond. 100th. anniversary of Nash motors. Looking for Nash parts NOS or used. 1917 Nash Quad truck/s. WW I recruiting posters. Navy ,Army and Coast Guard. Call Sieg in Alameda 510-316-3130 cell

CASTING CALL

LOOKING FOR WW2 PACIFIC THEATER MV'S
NAVY AND USMC
CIVILIAN BACKGROUND VEHICLES AS WELL
(30'S-EARLY 40'S)
FILMING IN ALAMEDA
INSURANCE AND RENTAL FEES WILL BE
PROVIDED
EMAIL PICTURES TO:
SFMOVIECARS@GMAIL.COM

THANKS
JOE HUNTER
415-310-2280



Lee Smith's Fundraiser at the Turlock Golf Course. My first year and definitely not my last! This is a GREAT event, my compliments to Lee Smith from Smith Chevrolet for going above and beyond in raising funds for Veterans. I've never seen that many golf carts in one area, I was really impressed... Outstanding!
 John Verissimo



Top: From Left to right, Mark Orozco, Paul Lubker, Juan Cortes, Don Gomes, Jess Soriano
Bottom: Paul Lubker in his GTB Ford Burma Cargo

John Verissimo



Military Vehicle Collectors of California
*Dedicated to the acquisition, restoration, preservation, safe operation,
 Public education and display of historic military transport*

WE WANT YOU
TO JOIN / RENEW
YOUR
MVCC
MEMBERSHIP!



INVOICE

Life Members should disregard this notice. THANK YOU for your support! If you have already renewed, THANK YOU! please check the date code on your newsletter mailing label and membership card. Is your expiration year "2017" ?

If it is this means your membership expires January 1, 2017. Please renew your membership.

Please enter an e-mail address for possible future methods of communication. If you list MV's or related hobby interest, it will show up on membership lists the MVCC Officers receive. Sometimes we want to contact members with certain MV's about displays or movie work. Note that you may opt-out of having contact or hobby information published in the next Member Directory booklet. This is your application. Separate it from the newsletter, or copy it, fill it out, and fold it put it in an envelope with your check inside, apply postage, and mail it. Simple!

* = required fields, please PRINT

*Name _____ MVPA # if applicable _____

*Address 1 _____

Address 2 _____

*City, State, ZIP _____ Country _____

Home phone _____ Cell phone _____

E-mail address _____

I DO / DO NOT want my contact information in the Directory (circle one)

List military vehicles you own (year, make, model) and/or related hobby for the next Directory. Help those with similar interests find you. Use separate sheet if necessary.

MEMBERSHIP (check one)

Term is Jan 1 – Dec 31

- \$35 regular member for one year only newsletter mailed
- \$85 regular member for three years newsletter mailed
- \$25 regular member for one year only newsletter online only
- \$60 regular member for three years newsletter online only
- \$60 business member (includes one, 2"x 3.5" ad in each newsletter (business card). No voting rights. A business member may also hold another class of membership

ASSOCIATE MEMBERS (spouse or significant other, and/or children under 18).

Includes membership card. Only spouse has voting rights.

One newsletter delivered per household

_____ Associates @ \$5.00 each per year, badge \$12.50

New members receive one badge. Associate Badges and replacement badges \$12.50 ea.

Amount enclosed _____

Print associate name and relationship to member

Christina Verissimo, c/o MVCC Treasurer,
 850 Elm Street Gustine, Ca 95322
 Make checks payable to the MVCC

*I DO / DO NOT want my MVs or hobby interests listed in the next Directory (circle one)