

the CALIFORNIA

MV

Collector

NEWSLETTER



EDITOR: DAVE BALL

April 2019

VOL. XLII



American troops in a Dodge weapons carrier pass the Castel Nuovo in Naples, October 1943  
NA

# MVCC BUSINESS MEMBERS

Brad Smardo  
I Pay CASH For Military Items

## Smardo-Militaria

No Item Too Small or Too Large  
Cell (916) 521-6221  
bsmardo@hotmail.com

Uniforms, Medals, Guns, Paperwork, Rifles  
Patches, Helmets, Flags, Knives, Pictures  
Field Gear, Pins, Badges, Hats, Swords, Caps

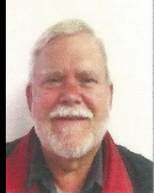

*"Where service comes  
first since 1926"*

**Smith Chevrolet  
Cadillac, Inc.**  
1601 Auto Mall Drive  
Turlock, CA 95380

**Lee C. Smith**  
Owner

(209) 632-3946  
(209) 988-8832 Cell  
(209) 667-7157 Fax  
leesmith@SmithChevroletCadillac.com



[smithchevroletcadillac.com](http://smithchevroletcadillac.com)



**ANGUS SMITH**  
Vice President of the Board  
Cell: (831) 240-5311  
AngusJSmith@Frontier.com

## GENERAL PATTON MEMORIAL MUSEUM

62510 CHIRIACO ROAD  
CHIRIACO SUMMIT, CALIFORNIA 92201  
[www.GeneralPattonMuseum.com](http://www.GeneralPattonMuseum.com)



## DOWNTOWN TRUCK PARTS

**NORMAN GORELICK**

20830 KINGSBURY ST  
CHATSWORTH CA 91311

1-818-709-3676

MACK6X6@AOL.COM

## MIDWEST MILITARY, INC.

[www.midwestmil.com](http://www.midwestmil.com)



PARTS & TRUCKS  
BUY • SELL • TRADE • RESTORE  
REPRODUCTION SHEETMETAL

**JOHN BIZAL**

Phone 952-440-8778 • Fax 952-440-8776  
16075 Hwy. 13 South, Prior Lake, MN 55372

## Central Oregon Surplus LLC

**Kyle Vanderhoef**

**Military Surplus  
Outdoor Gear  
and more**

PO Box 1371  
Redmond, OR 97756  
541-548-0946

[kylev@centraloregonsurplus.com](mailto:kylev@centraloregonsurplus.com)  
[www.centraloregonsurplus.com](http://www.centraloregonsurplus.com)

## NEW AND IMPROVED MD JUAN Vintage Restoration Parts

- Based on authentic and original measurements
- Well fitted
- Easy to install
- Ed coated - rust resistant
- Tested for almost 52 years



**MD JUAN**

## Jimmy Strauss

*The Expert in Military Vehicles*



530.919.2355

[jimmystrauss@hotmail.com](mailto:jimmystrauss@hotmail.com)  
[www.jimmystraussjeeps.com](http://www.jimmystraussjeeps.com)

# UPCOMING EVENTS

**April 3-7, 2019** 2nd SoCal MVCC annual rally and swap meet. The Soledad Rally has been moved to Lake Piru for more information visit [www.scmvcc.com](http://www.scmvcc.com) contact Richard Johnson for reservations and information (619)993-5284 or Email: [killroy321@hotmail.com](mailto:killroy321@hotmail.com) [www.camplakepiru.com](http://www.camplakepiru.com)

**April 12-14, 2019** Antique Tractor and Truck Show, Tulare, CA. Premier event with dry camping for RVs, great food and flushing toilets. contact Gary Hanes at [margiandgary@charter.net](mailto:margiandgary@charter.net) for details.

**April 16-21, 2019** Military Vehicle Collectors of California annual Spring swapmeet, campout and military vehicle rally. Held at our new location in Plymouth Ca. **49er village RV resort and Amador County Fairgrounds**. No vendor or visitor fee except camping fee. Lots of Free parking for day use. Contact: MVCC Wagonmistress Joann Lesser 408-238-8277 or 408-440-6068 email [mvcccampmistress@yahoo.com](mailto:mvcccampmistress@yahoo.com)

**April 28, 2019** Half Moon Bay Dream Machines Machinery, equipment, truck, car, tractor, motorcycle, air show. Food and Music plus much more... <https://dreammachines.miramarevents.com/>

**May 4, 2019.** Alameda Naval Air Museum. Swap Meet and Car Show 6:00 a.m. to 3:00 p.m. Early vendor check in and set up Friday, May 3rd, at 3:00 p.m. Military Vehicles get Parking in the Show Area and free entrance to the Museum, Vender spaces, \$ 40.00, 20' x 20, Cars for sale \$30.00 P.O.C. Mark Stroh, at 510- 432-1532 or Larry Pirack, at 510-522-6440.

**MAY 24-26, 2019** 4th Annual "BEST of the WEST" antique tractor, truck, MV Show/Warbird Fly In. Santa Margarita Ranch located on US 101 between Atascadero and San Luis Obispo.. Entry forms @ [www.thebestofthewestshow.net](http://www.thebestofthewestshow.net). Contact Gary Hanes with questions at [margiandgary@charter.net](mailto:margiandgary@charter.net).

**May 26, 2019** Castle Air Museum Open Cockpit Day 9am to 4pm POC: Don Gomes 209-765-1273

**June 15, 2019** Eagle Field Fly In Dinner, Dance and Military Vehicle Event. Onsite camping, bathrooms and showers. POC is Don Gomes (209)765-1273 [caddymanwestside@yahoo.com](mailto:caddymanwestside@yahoo.com)

**JULY 4, 2019** Danville 4th of July Parade: 2019 is the Centennial of the American Legion and they want to make this event special. The Grand Marshall is a past National Commander and the Danville Post would like to include members in the parade, which is where we come in, they have asked us to help with transport. We'll assemble at the south end of San Ramon Valley High School at 8:00 am, the parade starts at 9:00am. We cover 1.3mi. in about an hour and return to SRVHS. POC Andy Shyers (510)832-4322 or [mvcc510925@gmail.com](mailto:mvcc510925@gmail.com)

**JULY 20, 2019** Annual "Central California Cooler" presented by ATHS in NIPOMO, CA on US 101 between San Luis Obispo and Santa Maria. Antique trucks from pickups to 18 wheelers. Show is at Nipomo High School on Saturday, setup on Friday. Overnight bivouac. Contact: Gary Hanes at [margiandgary@charter.net](mailto:margiandgary@charter.net)

**September 11-15, 2019:** Camp Gridley Butte County Fairgrounds, Hosted by the NRG [www.northernrecongrou.org](http://www.northernrecongrou.org)

**MVCC Fall swapmeet???**  
Second largest annual Military Vehicle gathering and swap meet in the West.  
Location TBD...

# AT THE FRONT



Dave Ball, MVCC President  
(408) 805-0065  
vought@msn.com

Hello Everyone:

Two weeks - that's all the time you have to get loaded up and ready for the big one folks. Get your stuff packed and your vehicles ready to head out to Plymouth, California, to the largest West Coast swapmeet and military vehicle gathering.

Don't forget all the OD GI parts and go-withs that are laying around that you no longer have a need for. Bring them to swap. Turn your stuff into money and buy more stuff.

There is a lot going on this summer. The events page is filling up. Keep an eye on the events' column in the newsletters. Get those Fourth of July dates and events in ASAP.

In this newsletter, you will find several documents to help you find out what's going on at Camp Plymouth. The MVCC can always use help at the Quartermasters booth, so come by and help the club raise money to support the events. Come sell some shirts and club goodies.

If you have something to donate to the raffle, please drop it off at the Quartermasters booth.

All your donations go to fund the events and are appreciated.

Once again it's an election year. Why not step up and give back to your club. Throw your hat into the ring. Talk to a VP, come by the Quartermasters trailer or have a friend nominate you at the General Membership meeting Saturday at Camp Plymouth.

One last thing, don't forget to bring some sort of shade device, easy up, or camo net and a couple tarps just in case it should sprinkle a little. :-)

Hope to see everyone at Camp Plymouth. Safe travels.

“Keep 'em Rolling, Floating and Flying”

Dave Ball

President and Editor

Military Vehicle Collectors California

## MVCC FRONT OFFICE



Christina Verissimo, Treasurer  
(209) 918-0388  
crstna\_vrsmo@yahoo.com



John Verissimo, Secretary  
(209) 918-0488  
istanbull@sbcglobal.net

# Announcing the 2019 MVCC Board Elections

Time: Saturday, April 20, 2019, at 10:00 am

Place: General Membership Meeting

Where: Plymouth 49er RV Park

During the meeting, nominations will be taken from the floor for all board positions. Anyone interested in running for a position may also nominate themselves at anytime by giving their info along with the position interested in to the MVCC Secretary. Nominations will stay open until May 1, 2019.

Ballots will be sent out in the May newsletter.

The only positions not open to election are the Webmaster and Editor.

Although the Editor would like to retire and this position is open, if you are interested please talk to any board member.

Remember the club is run by volunteers. New blood always brings new ideas and keeps the club healthy. So please consider a board position. Help the club grow and become more involved in your hobby.



Don Gomes, Central Valley VP  
Divisions 209,559,661,760  
(209)765-1273  
caddymanwestside@yahoo.com

Greetings to all MVCC members...

I hope your all ready for Camp Plymouth I know I am .This will be a new adventure for all of us and a new area to explore and also lots of wine to drink!

Don't forget the Ford GTB and M6 Chevy Showcase on April 19th from 1pm to 4pm in the Fair Arena with First, Second and Third place awards.

Well back to my Ford GTBS Bomb service truck story .After the bed was finished and installed we set the crane on and bolted it down. Then I started on the wood box that covers the gas tank , with original plans from Bill Scott . Next I started looking for wood I knew I wanted old wood so I found some 100 year old 2in by 12in Bridge planks and milled them down with the help of a good friend Fred Beltran in Crows Landing Ca .Fred let me use his complete wood shop and mill. Next my son Zachary and I took two days to mill 10 boards then sanded and primed them. After painting I picked all the right boards for the right spots then drilled and screwed them together .I found old hardware to put the small tool boxes together and the boxes were done . The last thing to do was finish the top bows and canvas from Beachwood canvas company to make the GTBS stand out in a show! Thanks for reading all my installments on the restoration story of Froggy in the last 6 months ..

Don Gomes MVCC Central Valley V.P Keeping History Alive

# MVCC STAFF

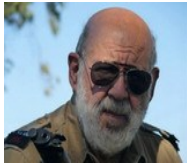

Jack Valenti, Central Coast VP  
Divisions 831, 805 408 south  
LRDG@PRODIGY.NET  
831-595-3487



Scott Rohrs, North. Bay VP  
Divisions 707 & 415 west  
415-259-8177  
recon3rdid@yahoo.com



Andy Shyers East Bay VP  
Divisions 510, 925  
510-832-4322  
mvcc510925@gmail.com



Kim Sievert, South Bay VP  
(408) 253-9469  
[vaudevillian@msn.com](mailto:vaudevillian@msn.com)  
Divisions 408, 669 North 650



Dave Porter, Northern Region VP  
Divisions 530 & 916  
dnporter56@comcast.net  
530-677-5115

## MVCC Camp Mistress Report

Jo-Ann Lesser

Heads up folks, we are coming down to the wire! Camp Plymouth is right round the corner. April 1st was the deadline for getting deposits on pre-registered sites at the 49'er RV Resort. If you missed the deadline and you have pre-registered for an RV site please give me a call. I may be able to help. I am available most days and evenings at 408.238.8277.

If you have reserved a site at the Amador County Fairgrounds your site must be paid in full prior to your arrival. Payment should be sent to: MVCC Treasurer, 850 Elm Street, Gustine, CA, 95322

Water/electric sites are \$35./night and dry sites are \$25./night.

We have a few spaces available at the 49'er as well as tent sites at the Fairgrounds. If you or a friend are interested in attending you will need to pre-register with me. There is a special club rate for those that contact me prior to April 1st. [mvcccampmistress@yahoo.com](mailto:mvcccampmistress@yahoo.com)

## Woody's

WOODY'S GOLF & INDUSTRIAL  
VEHICLES

Chris Dias

Sales, Parts, Rentals & Service

Authorized Dealer



The #1 Golf Car  
in the World!

P.O. Box 1628  
Turlock, CA 95381  
2900 E. Monte Vista Ave. fax  
209-667-9032  
[woodyscarts@yahoo.com](mailto:woodyscarts@yahoo.com)

209-634-2948

800-624-6091

## Woody's MANUFACTURING

Dick Dias

2900 E. Monte Vista Ave. P.O. Box 1628 Turlock, CA 95381  
209-634-2948 FAX 667-9032 800-624-6091  
Manufacturers of Quality Custom Metal Products

## **MVCC SECRETARY, JOHNNY VERISSIMO**

### **Good Morning MVCC Members!**

**Its getting to be that time year.** Planning is in FULL swing for the 2019 MVCC Military Vehicle Show and Swap Meet in Plymouth California! ... Actually we started working on Camp Plymouth the same week we left Camp Petaluma. Putting on an Event like this takes at least a year in preparation. I'm very happy to say we are going to Camp Plymouth. Location, Location, Location is everything and this new place has a great Location!

**Again I am looking for volunteers to help at the MVCC HQ Booth** Thursday, Friday and Saturday! The booth will be open from 10AM to 5PM all 3 days. This year I am doing something **NEW**, for every 2 hour shift you do at the MVCC HQ you will get a ticket for a drawing to win a \$50 gift certificate to the MVCC HQ Store! Yes, All MVCC Booth volunteers who put in a 2 hour shift get a ticket, if you put in 2 shifts you get 2 tickets. This is only for MVCC HQ Booth volunteers!

**MVCC Headquarters/Merchandise Booth/Dues HQ is at site 188 & 189.** Please stop by and say Hello! And maybe even buy something?!! Pay your dues, Or drop off a raffle item you would like to donate to help support your MVCC. We will have some raffle items on display throughout the event.

**If you would like to put your name down for a shift** please call me at (209)918-0488 or send me an email at [istanbull@sbcglobal.net](mailto:istanbull@sbcglobal.net). \$50 goes a long way at the MVCC HQ Merchandise Booth!!!

**I'm really looking forward to this new venue!** It has free parking, it has free admittance, free parking for car trailers, it has room to drive your MV's, it has room to grow and grow!

I look forward to seeing everyone in April! Meanwhile get your vehicles or sales items ready!

Johnny Verissimo

MVCC Secretary

[istanbull@sbcglobal.net](mailto:istanbull@sbcglobal.net)

(209)918-0488

[www.mvccnews.net](http://www.mvccnews.net)



## **MVCC NEWS STAFF**



**MVCC Editor Dave Ball**

**(408) 805-0065**    [vought@msn.com](mailto:vought@msn.com)

**Please submit all contributions for the newsletter by email to the editor by the 15 of the month.**



**Webmaster Sean Nichols**

[Jetnoise400@hotmail.com](mailto:Jetnoise400@hotmail.com)

[www.mvccnews.net](http://www.mvccnews.net)

**(775)-424-3813**

If you have any questions or have information regarding a meet or activity in your area, contact your regional vice president or any of the officers to let them know. Be sure to visit our website for any last minute activities or changes to activities/events. Please submit information regarding upcoming activities to the newsletter editor at least two months before the scheduled event. All articles must be submitted to the newsletter editor by the 15th of each month.

**MVCC News Editor Dave Ball** [vought@msn.com](mailto:vought@msn.com)

[www.mvccnews.net](http://www.mvccnews.net)

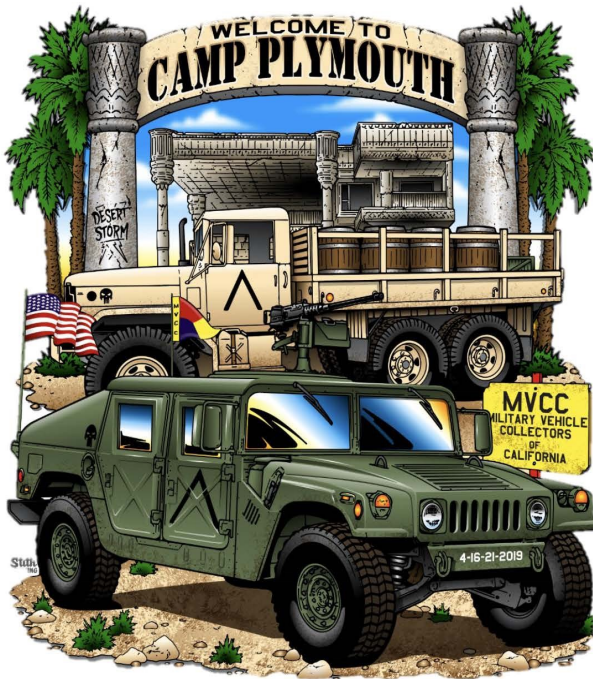

**MILITARY VEHICLE COLLECTORS OF CALIFORNIA**

# CAMP PLYMOUTH

## 42ND ANNUAL SWAP MEET & MILITARY VEHICLE DISPLAY

**PRESENTED BY MD JUAN**

*The Largest Annual  
Historic Military Vehicle Event in the West!*

**April 16-21\*, 2019**

*Plymouth, California*

*Replaces the Tower Park and Petaluma Venues*

All privately owned, former military vehicles welcome, any condition, NO vehicle registration fee

Parts & military collectibles swap meet for professionals & amateurs. NO seller fee but sellers must rent a campsite or cabin. Clean out your garage!

FREE admission. Friday Open House

FREE visitor parking at Amador County Fairgrounds Reserved military vehicle parking and "for sale" area

Military Vehicle Poker Rally on scenic area roads

Raffle Friday including a MD JUAN Ford Script Maxi-Kit!

Two themed military vehicle showcases on Friday with People's Choice Contests, cash awards - display yours!



**Jeep Showcase: WWII, Korea  
Vietnam, CJ pre-1987  
presented by MD JUAN**

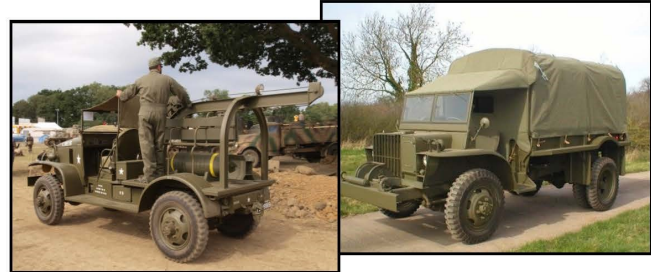

**Ford GTB & Chevy M6 Bomb  
Service Truck Showcase  
presented by Hagerty**

**NEW VENUE FOR THE SPRING MEET!**

RV or travel trailer camping, cabins, at 49er RV Village, discounts for MVCC members, see [www.MVCCNews.net](http://www.MVCCNews.net) for member info

Inexpensive tent camping at the Hagerty Tent Sector at adjacent Amador County Fairgrounds with gate connecting to the RV Village

Facilities at 49er RV Village for campers include pool, spa, clubhouse, laundry, store, café, play facilities, fishing

Visit 42 Amador County wineries & historic Gold Country towns

\* Early arrivals OK. Sunday is a pull out day, not a show day

For all camping contact Jo-Ann, 408-238-8277 or email [MVCCCampmistress@yahoo.com](mailto:MVCCCampmistress@yahoo.com), NOT the 49er office

Event info: visit the MVCC website or contact Don, 209-765-1273 or [caddymanwestside@yahoo.com](mailto:caddymanwestside@yahoo.com)

**VEHICLES , PARTS, MILITARIA**

**BUY, SELL, SHOW, DRIVE**

*49er RV Village, 18265 Hwy 49 and Amador County Fairgrounds  
Plymouth, California 95669*

**WWW.MVCCNEWS.NET**





# CAMP PLYMOUTH 2019 HISTORICAL SITE RUN



HISTORIC WATER-POWERED FOUNDRY  
AND MACHINE SHOP.

**SATURDAY, APRIL 20 1-3:30 PM**

---

Travel scenic backroads 9 miles to Sutter Creek. Group parking arranged nearby. Private group tour 2-3PM.

\$10 donation to Knight Foundry Alliance 501(C) requested.

More info at [knightfoundry.com](http://knightfoundry.com)

Sign up contact: Tim Coolbaugh

[timsresort@att.net](mailto:timsresort@att.net) 530-308-8164 Cabin 186

## Daily Briefing

### Camp Plymouth Presented by MD Juan – 16-21 April 2019

ALL WEEK – Swap Meet is open! Please check campsites through the 49'er RV Campground AND the Hagerty Tent Sector at the Fairgrounds next door for an amazing selection of items. Vendors MUST be in rented campsites, cabins or official tent spaces. Tickets will also be sold during the week for the special raffle prize of a 1942 Ford Script Maxi Kit donated by MD Juan!

#### Tuesday, April 16

##### Swap Meet Begins!!

1800 – EARLY BIRD POTLUCK DINNER. Rec Hall. Bring your utensils, plate, food to share. POC – Jo-Ann Lesser/Cabin #5

#### Wednesday, April 17

##### Swap Meet Continues!!

1200-1700 – WINE WEDNESDAY CONVOY. Meet at 1145 in parking lot of the Pokerville Market across the street with your MV to convoy to select Shenandoah wineries. POC – Jennifer Tanis / Swamp

#### Thursday, April 18

##### Swap Meet Continues!!

0700 until coffee's gone - Early Morning Coffee. Location: Hagerty Tent Sector with specific site to be announced later.

1000 - POKER RALLY CONVOY. Meet @0930 in the Parking Lot of the Pokerville Market across the street from the campgrounds. Register at the table outside the market to receive your driving orders. First vehicle goes out at 10. Price is \$5 per poker hand, maximum of 1 hand per person. (Money taken in will be returned in the form of prizes to people with the 3 best poker hands.) - POC – Dave Porter (Northern CA VP) 530-391-8006 / Swamp

1000 – 1600 – MVCC HQ/Store Open at Sites #188 & 189, near the Rec Hall. JOIN OR RENEW, meet MVCC officers, see who is camping where, drop off raffle items, buy the GREAT MVCC Commemorative memorabilia. Support the MVCC!

1400 – WOMEN OF THE MVCC GATHERING. Rec Hall. Special guest speaker from Native Daughters of the Golden West. Bring any food you'd like to share and BYOB – Bring Your Own Beverage

1600 – MVCC Board Meeting – Location to be determined.

1700 – 1900 - BARBECUE DINNER ONSITE. Rec Hall. Presented by Incahoots well-known local BBQ & catering

#### Friday, April 19

##### Swap Meet Continues!!

0700 until coffee's gone - Early Morning Coffee. Location: Hagerty Tent Sector with specific site to be announced later.

0900 – WOMEN'S OFFSITE BRUNCH AND SHOPPING EXPEDITION. Meet @ 0845 near the front entrance by the Rec Hall. We will be heading to a local restaurant for brunch, then have time for some boutique and antique shopping in the historic Gold County. All welcome; need drivers. POC – Nancy Porter (530-391-5650) / Swamp

0930 – 1100 – JEEP SHOWCASE Sponsored by MD Juan. Location: Arena at the front of the Hagerty Tent Sector

1000 – 1600 – MVCC HQ/Store Open at Sites #188 & 189. Near the Rec Hall. JOIN OR RENEW, meet MVCC officers, see who is camping where, drop off raffle items, buy the GREAT MVCC Commemorative memorabilia. Support the MVCC!

1300-1600 – FORD GTB & CHEVY M6 TRUCK SHOWCASE Sponsored by Hagerty Insurance. Location: Arena at the front of the Hagerty Tent Sector

1700 – BARBECUE DINNER & RAFFLE. Rec Hall. Dinner by Incahoots, well-known local BBQ & catering

#### Saturday, April 20

##### Swap Meet Continues!!

0700 until coffee's gone - Early Morning Coffee. Location: Hagerty Tent Sector with specific site to be announced later.

**Before 1000 – All planning to go on the Knight Foundry Convoy at 1300 should move their vehicles to the Wolin Arena area.**

1000 – MVCC GENERAL MEMBERSHIP MEETING. Location to be announced.

After General Meeting to 1600 – MVCC HQ/Store Open at Sites #188 & 189, near the Rec Hall. JOIN OR RENEW, meet MVCC officers, see who is camping where, buy the GREAT MVCC Commemorative memorabilia. Support the MVCC!

1300 – There will be a community Easter Egg Hunt held by the 49'er Campground.

1300 – 1530 – Convoy to historic Knight Foundry. \$10 per person requested donation. POC – Tim Coolbaugh / Cabin #186



## **CAMP PLYMOUTH POKER RALLY**

**THURSDAY , 18 APRIL 2019**

## **DRIVE YOUR MILITARY VEHICLE IN THE CAMP PLYMOUTH POKER RALLY**

**Thursday, 18 April 2019**

**Start at Pokerville Market Parking Lot,  
18170 Hwy 49, Plymouth, CA**

**Registration at 0930**

**First vehicle out at 1000**

**End at the 49er RV Resort**



## **WIN CASH PRIZES !!!**

Follow Written Instructions and Drive through parts of the scenic  
Shenandoah Valley and Amador County



**Only \$5 per hand. No experience necessary!  
Best Poker Hand wins HALF THE POT!**

# CAMP PLYMOUTH

42<sup>nd</sup> Annual West Coast  
Military Vehicle Rally & Swap Meet  
16-21 April 2019

49er Village RV Resort and Amador County Fairgrounds  
18265 Highway 49  
Plymouth, CA 95669

## OPERATIONAL ORDERS – as of 10 Feb 2019

(Previously known as Basic Training)

This is a new location for the largest annual Military Vehicle swap meet and gathering on the West Coast. The new venue is located at the 49 Village RV Resort and adjacent Amador County Fairgrounds in the Historic California Foothill Gold Country at Plymouth, Amador County.

**OP ORDER 16-21.4.19:** MVCC Bivouac Rules and Regulations for the Spring 2019 Event

### **CAMPING**

1. Official event dates are Tuesday, 16 April thru Sunday, 21 April, 2019. Group discount rates at the 49er are valid 3 days before and 3 days after the event on a space available basis.
2. Cabins and RV camping only at the 49er, no tent camping allowed.
3. Tent camping at the Fairgrounds, no large RVs (unless there is no space at the 49er).
4. Tent camping at the Fairgrounds is mostly dry camping. A limited number of sites with water and power are available, but are already reserved as of this writing.
5. 4 night minimum reservation at the 49er for RV camping (may be waived by 49er management).
6. No minimum reservation for tent camping at the Fairgrounds. Full payment for camping at the Fairgrounds is required at time of reservation.
7. One night reservation deposit at the 49er is required upon booking a reservation. Balance due on arrival. Express Check-in is available for those paying in full when paying for reservations.
8. All reservations for RV and tent campsites will be booked and coordinated through the MVCC Camp Mistress (JoAnn Lesser) at [mvcccampmistress@yahoo.com](mailto:mvcccampmistress@yahoo.com).
9. Campfires are permitted in above-ground fire pits at the 49er and at the Fairgrounds.
10. The 49er and the Fairgrounds are pet friendly. Dogs must be kept on a leash in public areas.
11. Discharge of firearms is prohibited at the 49er and the Fairgrounds.

### **DAY USE AND PARKING**

12. No MV registration is required. Bring 'em all.
13. Free visitor parking at the Fairgrounds. No long term visitor parking within the 49er Resort.
14. Vehicle access is through the front gate at the 49er and the Empire Street gate at the Fairgrounds.
15. Free trailer and tow rig parking at the Fairgrounds.
16. No admission charge to attend the meet. No wrist bands required.
17. No vehicle parking on lawn areas due to the presence of underground sprinkler systems.
18. Roads in the 49er and the Fairgrounds shall not be blocked by parked vehicles at any time.

### **SWAP MEET and DISPLAYS**

19. No fee for buying or selling at your campsite, except for campsite rental.
20. Swap meet is event-wide at the 49er and Fairgrounds campsites.
21. Vendors must rent an RV or tent campsite to sell merchandise.
22. Open House with the local public invited will be held on Friday, 19 April from 1000 to 1700 hours. Meet participants are encouraged to be present during Open House hours. Period dress, military uniforms and vehicle displays are encouraged.
23. Free vehicle and foot traffic access to the 49er and Fairgrounds to view displays and participate in the Swap Meet is permitted.
24. Foot traffic access is available through a gate between the Fairgrounds and the 49er. Gate is located between 49er campsites 23 and 25, and the southeast corner of the Fairgrounds Arena.
25. Tracked vehicles with steel grousers may not be driven on paved areas within the 49er or Fairgrounds campgrounds.
26. Military-themed displays are allowed and encouraged at campsites in both campgrounds.
27. Special Displays can be accommodated free of charge in the Fairgrounds, outside designated campsites.
28. Normal campsite rental fee is required for Special Displays not in a campsite if also used for overnight accommodation (sleeping overnight within the display).

### **AMENITIES**

29. Amenities at the 49er include: Pool, hot tub, volleyball, shuffleboard, horseshoes, billiards, kids playground, Rec Hall with kitchen, Amphitheatre, Terrace, Café, restrooms with showers, laundry, store, propane, limited temporary parking.
30. Amenities at the Fairgrounds include: restroom with showers, unlimited parking (except on fire access roads within the tent camping area), limited water and power.
31. Hotels, restaurants, grocery store, antique stores, hardware store, Indian Casino, Wineries, Historic Gold Rush towns and sites and other attractions are within a short distance of the campgrounds.

**See the Daily Briefing for detailed information on daily activities.**

# MVCC BUSINESS MEMBERS



Department of California  
**DAV**  
Established 1921

**ANDREW MOJARRAS**  
JR. VICE COMMANDER  
2017-2018

P.O. Box 1872  
TURLOCK, CA 95380

(209) 712-8572  
andrewcadav@gmail.com  
www.davcal.org

**FULFILLING OUR PROMISES**  
TO THE MEN AND WOMEN WHO SERVED

Dc Truck parts 541-772-8992

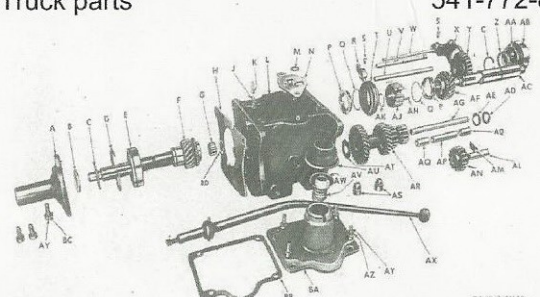

Dave Cirillo dctruckparts@msn.com

## EXPEDITION IMPORTS

*Get Out of the Ordinary!*

**Scott Ingham**  
President

scott@expedition-imports.com

www.mpttires.com  
www.expedition-imports.com

1335 Lemon Street  
Vallejo, CA 94590  
Tel 707.643.6757  
Cell 707.319.7252  
Fax 707.643.2998

**Ray Del Pino**  **DMV License #VV17807**

ANTIQUE • CLASSIC • MODERN  
**VIN NUMBER VERIFICATION**  
AT YOUR LOCATION IN SOUTHERN CA  
TRUCKS, TRAILERS, SPECIAL MOBILE EQUIPMENT  
MOTOR HOMES, AND CARS  
DMV RUNNER SERVICE  
CLASS C DRIVEAWAY - GETAWAY DRIVER  
15708 E. Grovecenter St. • Covina, CA 91722  
Cell: (626) 391-2167 • Home: (626) 814-2196

## JAY'S WWII JEEPS

Specializing in vintage WWII Willys MB/Ford GPW vehicles and parts

**1-844-WW2-JEEP**



Jay Hinton | Napa, California USA | 1-844-992-5337 | jay@jaysww2jeeps.com



**CARSON PLAINS SURPLUS & STORAGE**  
Military Surplus, Military Vehicles, Storage, Firewood

**JON BIRCHEFF**  
Owner



P.O. Box 1289  
70 S. Rainbow Dr  
Dayton, NV 89403  
Cell: 775-246-7186  
Fax: 775-241-7142  
jon.cpsands@gmail.com  
www.cpsands.com

**California Cars AB, USA**  
prlubker@gmail.com



**Paul Lubker** Cell 209.403.6261

754 Loquat Ave.  
Patterson, CA 95363

MILITARY VEHICLE COLLECTORS of CALIFORNIA

# JEEP SHOWCASE

## PEOPLE'S CHOICE CONTEST

WWII - Korea - Vietnam - CJ - Pre 1987

*Presented by MD Juan*

*Hosted  
by:*



*In association  
with:*

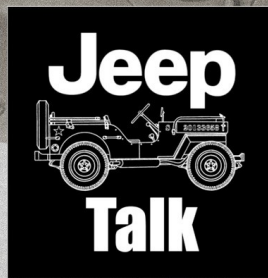

Amador County Fairgrounds, Plymouth CA

***Friday 19 April 2019***

 **MD JUAN**

The logo for MD Juan features a stylized blue and white icon resembling a speech bubble or a social media symbol, followed by the name "MD JUAN" in a bold, white, sans-serif font on a black background.

*For more information go to: [www.mvccnews.net](http://www.mvccnews.net)*

# CLASSIFIEDS

**FOR SALE:** Dodge M37 parts inventory for sale as a lot on eBay – if you're interested in buying out my entire selection of remaining M37 parts – please check eBay. These parts will be available for pickup in Geyserville, CA or we may be able to arrange shipping if needed. Questions?  
Richard Privat 707-484-8257 (call or text) or email rpironman@hotmail.com 4-19

**FOR SALE:** GMC 2-1/2 ton 6x6 & Chevrolet 1-1/2 ton 4x4 WWII parts inventory for sale as a lot on eBay – if you're interested in buying out my entire selection of remaining parts – please check eBay. These parts will be available for pickup in Geyserville, CA or we may be able to arrange shipping if needed. Questions? Richard Privat 707-484-8257 (call or text) or email rpironman@hotmail.com 4-19

**WANTED:** Early Dodge WC parts wanted to include; complete windshield assy., bucket seats, marble reflectors, blackout and taillight, wiring harness, tailgate, good tires.... 1898kma@gmail.com Calvin 4-19

**WANTED:** US WWII Small Wall Tent in good condition. John at 415-847-2801 or in\_garage@hotmail.com 4-19

**FOR SALE:** from collector's estate, 500+ books covering all things military including uniforms, specific events, vehicles, some in German, also 140+ uniforms. Nothing too exciting but lots of wearable from WWII to current issue.  
Lee Edwards 925-447-9387 or [whenlde@aol.com](mailto:whenlde@aol.com)

**WANTED:** Chevrolet M1008 K30 1 ¼ Ton Military Truck in good original running condition from 1984 to 1987 – the later the better. Should have clear title and should be located in Central/Southern California. Herman Pfauter, Santa Barbara. Email HP2@WEST.NET, Telephone 805-964-9449.” 4-19

**FOR SALE:** M100 Trailer rough great for hauling parts to swap meets. \$450obo, Ben Hur wooden side rack with all metal brackets wood rough good for patterns . \$180obo WW2 antenna mount square swinging type . \$150obo Ford GTB battery box great condition . \$150 . 2 G506 or M6 , CCKW Chevy 20in rims blasted& primed \$250 obo . 1 M5 Bomb trailer rough condition parts maybe restore \$450 obo Also will trade for WW2 Bomb Ordnance equipment. Call or text Don 209-765-1273 4-19

**FOR SALE:** 1943 GTBS not running has good tires crane winches are frozen but in good shape also has civilian engine .. \$1700obo also have 1943 MBT trailer needs rust repair has Lunette hitch, brake handle , 1 original chain, Data plate and folding leg \$750.obo Don . 209-765-1273 4-19

**FOR SALE:** Misc. Jeep Parts Military and CJ GPW fenders ( rough ) Axle Housings Generators 6v & 12V Springs Motors- 4cyl F head (running when pulled) 6cyl Willys Hurricane Engine (same) Bell Housings GPW and CJ GPW Radiator (core) and so much more! Call Scott 415 259 8177 4-19

**FOR SALE:** Burma Ford cargo truck for restoration ( if desperate ) or for parts. Has bed, winch and other parts. Located in Livermore \$1100 email for pictures. Lee 925-447-9387 whenlde@aol.com 6-19

**Classified Ads** are free for military vehicle related items and kit for MVCC members. Your ad will run for three issues. Your editor will only except ads in writing. Please submit your ad by email: vought@msn.com or by post to: MVCC Editor: 18549 Paseo Tierra St. Saratoga Ca. 95070. Please print clearly and include contact info and price. Please submit ads by the 15th of the month. If you want to make changes to your ad including extending or cancelling your ad, you must notify your editor in writing. The MVCC is not responsible for omission's or Incorrect wording and or spelling. The MVCC reserves the right to edit ad copy for space. Please send payment for paid ads to: LK Viola, Email: sec-treasurer@mvcnews.net

**Ad prices: full page \$45 Half page \$35 Quarter Page \$20 Business Card \$5 per issue**



# CLASSIFIEDS

**FOR SALE:** 2014 Enclosed Trailer \$6,750 OBO  
Custom built 7' x 14' enclosed LOOK trailer. Fully factory insulated. Can be used as a bunk house (complete with electricity, heater, lights, and desk) once vehicle is removed. The US flag is painted on the roof. New Goodyear tires with leaf springs (installed 2017), E-track mounted and back plated, internal winch added, ramp door upgraded to 4,000 lb. capacity. Used to transport an M38 A-1 to starting locations for the 2015 and 2017 MVPA convoys. Dolly adjustable trailer mover and E-track tie down straps included with purchase. Picture to the right email Traci. traci.parent@yahoo.com 4-19



**FOR SALE:** 1952 GMC 2 1/2 ton truck, running \$4500, 195? M38A1 body \$400 ( may have springs and axle to fit at extra cost), WWII M63 ground mount 50cal \$1250, all sorts of uniforms, naval items, helmets, and all the crap no one needs but everyone should have. Lee Edwards 925-447-9387 whenlde@aol.com 4-19

**FOR SALE:** 1952 M38A1 has all seats needs cushions and is still 24 volt needs resto or work to get it on the road. Condition is much better than Jeeps at this price . No rot couple small spots of rust to repair. Ran when bought and has sat for a couple years. Great project Jeep. \$2500 cash. Call or email Dave 408-805-0065 vought@msn.com picture to the right. 4-19



**FOR SALE:** New Metal brackets for wood side racks on a WWII one ton trailer. \$230.00 at camp.

Radio box CH74A that fits WWII jeeps and Dodge WC 51 and 52. \$ 100.00 at camp. Let me know if you want a radio box so I can bring the correct quantity to the meet.

Dodge WC 1/2 ton floor boards \$75.00 and dash map boards \$10.00 at camp.

Dodge WWII running board bolts NOS \$2.00 ea. at camp.

Save shipping cost and buy the products at Camp Plymouth. Contact Greg Lampman (805) 550 5838 or e-mail at glampman@calpoly.edu 4-19

## Good Morning MVCC Members!

Its Official that MD Juan is the April 2019 MVCC Event Sponsor! And! MD Juan has donated a complete **MD Juan 1942 Ford Script Tub/Body Jeep Kit!** That's RIGHT, THE WHOLE KIT in a Box! to the MVCC April Event raffle on April 19<sup>th</sup> at 6PM! I know it sounds crazy but its TRUE. You can buy your Jeep Raffle Tickets at the MVCC Booth at the **Camp Plymouth 42<sup>nd</sup> Annual Swap Meet & Military Vehicle Display this April!**

**I have made 1,000 special MD Juan Jeep Raffle tickets.** They will be sold at **\$5 each.** Buy as many tickets as you like. If you would like to see the kit just go to [www.mdjuan.com](http://www.mdjuan.com) . It's a jeep in a crate.

**Proceeds from this raffle will help the MVCC** to advertise its events more, buy office supplies, merchandise and help offset the costs of higher mailing costs just to mention a few.

**This will be one of the coolest raffle prizes we will have in recent MVCC history.** I guess you could say you need to be present to win because you will need to take it home after the raffle! Lol. Yes the MD Juan Kit will be on display at the MVCC HQ Booth during the April Event so come by and check it out!

If you have any questions please feel free to ask...

## Remember to buy your tickets at Camp Plymouth

Johnny Verissimo  
MVCC Secretary,  
(209)918-0488  
[istanbull@sbcglobal.net](mailto:istanbull@sbcglobal.net)  
MVCC on FB  
[www.mvccnews.net](http://www.mvccnews.net),

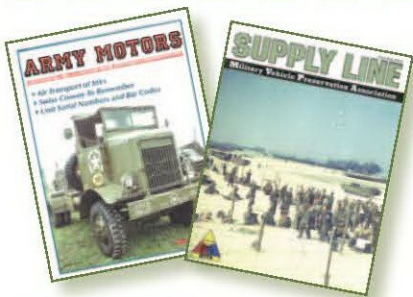

## Military Vehicle Preservation Association

### History In Motion

*Since 1976 the Military Vehicle Preservation Association's mission is to provide an international organization for military vehicle enthusiasts, historians, preservationists and collectors interested in the acquisition, restoration, preservation, safe operation, public education and display of historic military transport.*

**All membership types include all MVPA Periodicals**

#### U.S.A. MEMBERSHIPS

- Second Class Postage - \$50.00
- First Class Postage - \$75.00

#### MEMBERSHIPS OUTSIDE THE U.S.A.

- Canada Economy Air - \$60.00
- International Economy Air - \$70.00

#### OUTREACH SPONSORSHIP

- To US Organization or School
- Second Class Postage - \$50.00

#### Electronic Membership

- Worldwide E-Membership - \$35.00  
(Does not receive Printed Publications)

MVPA Recruiting Member \_\_\_\_\_ Membership Number: \_\_\_\_\_

Name of Applicant \_\_\_\_\_

Address \_\_\_\_\_

City \_\_\_\_\_ State \_\_\_\_\_ Zip \_\_\_\_\_

Telephone \_\_\_\_\_ E-mail Address \_\_\_\_\_

16 Digit Credit Card # \_\_\_\_\_

Exp. date \_\_\_\_\_ / \_\_\_\_\_ Signature \_\_\_\_\_

*Complete this application and mail with a check or money order (on a U.S. bank in U.S. funds) to the address below.*

**MVPA ☉ PO Box 520378 ☉ Independence, MO 64052**

Phone: (800) 365-5798 ☉ E-mail: [hq@mvpa.org](mailto:hq@mvpa.org) ☉ Fax: (816) 833-5115





**Military Vehicle Collectors of California**  
*Dedicated to the acquisition, restoration, preservation, safe operation,  
 Public education and display of historic military transport*

**WE WANT YOU**  
**TO JOIN / RENEW**  
**YOUR**  
**MVCC**  
**MEMBERSHIP!**



**INVOICE**

Life Members should disregard this notice. THANK YOU for your support! If you have already renewed, THANK YOU! please check the date code on your newsletter mailing label and membership card.

*Please enter an e-mail address for possible future methods of communication.* If you list MVs or related hobby interest, it will show up on membership lists the MVCC Officers receive. Sometimes we want to contact members with certain MVs about displays or movie work. Note that you may opt-out of having contact or hobby information published in the next Member Directory booklet.

This is your application. Separate it from the newsletter, fill it out, and fold it put it in an envelope with your check inside, apply postage, and mail it. Simple!

\* = required fields, please PRINT

Name \_\_\_\_\_ MVPA #if applicable \_\_\_\_\_

\*Address 1 \_\_\_\_\_

Address 2 \_\_\_\_\_

\*City, State, ZIP \_\_\_\_\_ Country \_\_\_\_\_

Home phone \_\_\_\_\_ Cell phone \_\_\_\_\_

E-mail address \_\_\_\_\_

I DO / DO NOT want my contact information in the Directory (circle one)

List military vehicles you own (year, make, model) and/or related hobby for the next Directory. Help those with similar interests find you. Use separate sheet if necessary.

\_\_\_\_\_

\_\_\_\_\_

MEMBERSHIP (check one) (Term is 1 full year!)

\$35 Regular Member newsletter mailed

\$85 Regular Member for three years Newsletter Mailed or Online circle one

\$25 Regular member newsletter Online

\$60 Business Member (includes one, 2"x 3.5" ad in each newsletter (business card). A Business Member may also hold another class of Membership

ASSOCIATE MEMBERS (spouse or significant other, and/or children under 18). Includes membership card. Only spouse has voting rights. One newsletter delivered per household

\_\_\_\_\_ Associates @ \$5.00 each per year, Membership Badge \$10 Each.

Replacement badges \$ 10 EACH Amount enclosed \_\_\_\_\_

Print Associate Name \_\_\_\_\_ Relationship to Member \_\_\_\_\_

\_\_\_\_\_

\_\_\_\_\_

\_\_\_\_\_

\*I DO / DO NOT want my MVs or hobby interests listed in the next Directory (circle one)

**Christina Verissimo, c/o MVCC Treasurer,**  
**850 Elm Street Gustine, Ca 95322**  
**Make checks payable to the MVCC**

Military Vehicle Collectors of California Merchandise 2019



**2019 MVCC Camp Plymouth**

Tshirt. This year we chose A

**Desert Storm Theme, Olive Drab and Tan Tshirts**

Size: S,M,L,XL - \$20 each

Size: XXL, XXXL - \$22 each

**Zip Up Hoodie Sweaters, Limited Edition, ONLY 21 Made!**

Sizes: S,M, L, XL - \$55 each

Sizes: XXL, XXXL - \$60 each

(Olive Drab Color)

**Limited Quantities, Call Don Gomes for pre-orders**

(209)765-1273

**Everything will be for sale at Camp Plymouth 2019! Come by and check out the MVCC HQ Store/Trailer for more items!!!!!!**



**40<sup>th</sup> Anniversary**

MVCC Patch 4

inch

\$3 each



**25<sup>th</sup> Anniversary**

MVCC 4 inch

patch

\$4 each

**Custom MVCC Name Badge**

\$10 each shipped to you!

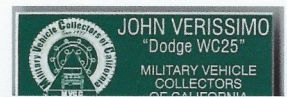

**MVCC Patch**

3 ½ inch

\$3 each



**MVCC Magnate**

3 inch

\$2 each

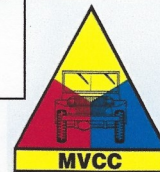

**MVCC Sticker**

3 inch

\$2 each



**MVCC**

**Sticker**

2 inch

\$1 each



**MVCC Antenna**

**Flag**

Custom Made!

\$25 each



**MVCC**

**Hats!**

\$20 each!

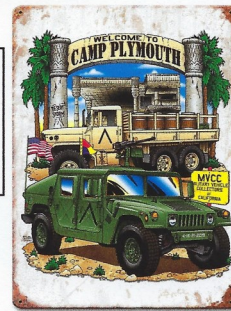

**2019 Camp**

**Plymouth**

Artwork Metal

Sign.

11.5 X 14.5 size

\$25 each

**How to purchase:** You can email or call your order in to Don Gomes(209)765-1273. He will let you know if its in stock and give you a shipping quote. **How to pay:** Check or Money order. The club is working on getting a paypal account but its not ready yet. **Shipping:** Average shipping is \$6.99 but if it's a really small order it can be less or if it's a large order it might be more, out of country is more. **Ships from Gustine, Ca.** Email at [istanbull@sbcglobal.net](mailto:istanbull@sbcglobal.net) Any questions please ask! WE also have a few previous years event tshirts and other stuff like coffee mugs etc. **Mail payment to MVCC Treasurer, Christina Verissimo, 850 Elm Ave, Gustine, Ca. 95322**