

the CALIFORNIA

MV

Collector

NEWSLETTER



EDITOR: DAVE BALL \*

2017

\* VOL. XL, NUMBER 8



Gerry Bowen's beautiful Dodge 1942 1/2 ton WC-24 Command Car with winch. This Command car has been a regular and a favorite at MVCC events. It is in the classifieds for sell in this issue.  
Ed.

# CONTENTS

**UPCOMING EVENTS** ..... 4, 5

**MVCC STAFF** ..... 3,6,7

**CLASSIFIEDS** ..... 14, 15

**MVCC MEMBERSHIP APPLICATION** ..... 18



Chris Thomas's CCKW Shop van Seen at Tower Park April 2012

PVT. Parts

**JAY'S  
WWII JEEPS**

Specializing in vintage  
WWII Willys MB/Ford GPW  
vehicles and parts

**1-844-WW2-JEEP**



Jay Hinton | Napa, California USA | 1-844-992-5337 | jay@jaysww2jeeps.com

**CLASSIC MILITARY AUTOMOTIVE**

A division of  
**CMA North Bay**

Shop: 1385-B CASS RD, SANTA ROSA, CA 95406  
Mailing: PO BOX 6167, SANTA ROSA, CA 95406

Phone: 707-542-4353  
Fax: 707-544-8230

Email: [gpajeeep@yahoo.com](mailto:gpajeeep@yahoo.com)  
[www.classicmilitaryautomotive.com](http://www.classicmilitaryautomotive.com)



Ask for  
**TERRY O'CONNOR**

*1941 to 1954 AWD military vehicle sales, restorations & repairs*

# AT THE FRONT



Dave Ball, MVCC President  
(408) 805-0065  
vought@msn.com

Hi, Everybody

Well August is gone and here we are just a few weeks away from our Fall swapmeet, which is being held at Jellystone Park in Lodi formerly known as KOA Tower Park.

I hope everyone is still enjoying summer as we wind down and move towards fall.

I plan on arriving at Camp Jellystone on Wednesday, September 20. I am in Cabin 170 if you would like to talk to me.

Friday morning at 10am, we will have an impromptu General Membership Meeting somewhere near Cabin 170 by the exit ramp. You will need to bring a chair to sit, so look for the group. Hopefully we can find some shade.

I have been in contact with Petaluma KOA talking with Woody, the park owner, about some of our concerns from last year. Some of these issues, we may need to come up with some internal solutions to such as the shuttling of day visitors in and out of the park and giving those that have a hard time getting around rides in our Jeeps, especially up the sloping roads. We also need to make some signage and get the word out on the use of the onsite trailer storage area being offered to those camping to park overflow vehicles and trailers.

This was an election year, and I want to thank all those that returned their ballots. A special thank you to Randy Canova and Claude Morey for counting the ballots and submitting the report to our Secretary, John Verissimo. Those results will be in Newsletter #9, and John will report the results to the members at the GM.

Looking forward to seeing everyone.

Keep em flying floating and rolling,

Dave

# MVCC FRONT OFFICE

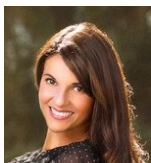

Christina Verissimo, Treasurer  
(209) 918-0388  
crstna\_vrsmo@yahoo.com



John Verissimo, Secretary  
(209) 918-0488  
istanbull@sbcglobal.net

# UPCOMING EVENTS

## **April 24-29, 2018 Spring Meet Petaluma KOA.**

No vendor fee except camping fee.

Contact: MVCC Wagon Master

Jo-Ann Lesser; (408) 238- 8277

[mamalesser@yahoo.com](mailto:mamalesser@yahoo.com)

**September 9-10, 2017** California Capital Airshow  
Sacramento County's Mather Airport 10425 Norden  
Avenue Mather, CA 95655

<http://CaliforniaCapitalAirshow.com>

**September 12-17, 2017:** Camp Gridley  
Butte County Fairgrounds, Hosted by the NRG  
[www.northernrecongroup.org](http://www.northernrecongroup.org)

**Sept 23-24th 9:30am -4:00pm** Northern  
California Veterans Historical Association presents  
2nd Annual Military History & Combat Vehicle  
Show Redding Calif. Highway 273 at Old Sky Ranch  
Airport Overnight camping and RV onsite Vendors  
and Collectors welcomed.....all participating entrants  
free

Contact: Jerry 530 739-2562

or [mountainmilitary@icloud.com](mailto:mountainmilitary@icloud.com)

**September 19-24, 2017 Fall Camp Delta**  
Second largest annual Military Vehicle  
gathering and swap meet in the West.  
Location Tower Park resort Jelly Stone Park  
For reservations please call Joann lesser  
408-238-8277

[www.mvccnews.net](http://www.mvccnews.net)

**September 23, 2017** Gustine Fly in, Gustine Airport  
8am to 4pm call Don Gomes - 209-765-1273

**September 30, 2017** – 9am to 4pm The Central  
Valley Aviation Association “Remember When” 3rd  
Annual Classic Fly-In and Classic Car Show Fresno  
Chandler Executive Airport (KFCH)  
510 W. Kearney Blvd., Fresno, CA 93706  
Classic Car Admission \$20 pre-registration, \$25 day  
of event Dash plaques for the first 60 cars  
Call Arnie for more information (559) 816-8461

## **October 2-9, 2017 Fleet Week San Francisco.**

Three day Air show with Blue Angels and Canadian  
Snow Birds plus several other aircraft military and  
civilian. Also Tour the USS San Diego LPD 22  
Friday the 6th has the parade of ships 10am to noon  
with the airshow following. Marina Green is the  
center stage.

<https://fleetweeksf.org/>

Contact Kim Sievert he may have a contact at Fort  
Mason for vehicle display.

SEE MIDDLE PAGE 5 =====>  
FOR ALAMEDA SWAP MEET OCT. 21

**November 5, 2017** American Legion Post 237 in  
Pleasanton CA. Will be celebrating Veterans Day  
with a Hometown Parade the Sunday before the hol-  
iday. The Parade theme this year is Medics of the  
Military, and we have at least two Medics, one Vet-  
eran and one currently serving. Elizabeth C. Freitas  
Asst. Adjutant- American Legion Post 237  
Pleasanton CA

<http://www.americanlegionpost237.org/>

[elizabethbugster@gmail.com](mailto:elizabethbugster@gmail.com)

**November 10, 2017** 9am to 4pm Turlock Veterans  
Charitable Trust. Turlock Golf Course please bring  
MV's for static displays around course free food and  
drink for participants !!

Call Lee Smith 209-988-8832

If you have any questions or have information regarding a meet or activity in your area, contact your regional vice president or any of the officers to let them know. Be sure to visit our website for any last minute activities or changes to activities/events. Please submit information regarding upcoming activities to the newsletter editor at least two months before the scheduled event. All articles must be submitted to the newsletter editor by the 15th of each month.

**November 11, 2017** San Jose United Veterans Council of Santa Clara County.  
Veterans Day Parade, South S.F. Bay Area  
Saturday November 11th in San Jose  
Staging area somewhere on Almaden Blvd  
Normal staging place, is near SAP Center on West Santa Clara Street at Almaden Blvd  
Abnormal staging place, is further South of West Santa Clara Street on Almaden Blvd  
Requested arrival time is before 9 am  
Parade starts 11 am  
Email for updates / conformations to vaudevillian@msn.com  
http://www.uvsc.org/VetParadeInfo.htm  
E mail Kim Sievert: vaudevillian@msn.com

**November 11, 2017** Petaluma Veterans Day Parade.  
This Annual North Bay Parade, begins at 1 p.m., starting point at Walnut Park at "D" Street, For info: Scott Rohrs 415-259-8177 recon3rdid@yahoo.com

**November 11, 2017** Gustine Veterans Parade downtown Gustine line up 9am.  
call Don Gomes -209-765-1273

**November 11, 2017** Redwood City Veterans Day Static vehicle display drivers should check in on Broadway between Hamilton and Middlefield. Vehicle owners will receive a Certificate of Participation. Request your arrival time is between 7 and 8 am, so they can move participants to the staging area before the vendors get onsite. Ceremony starts at 11 am POC is Chris Cheshire email: ccheshire@yahoo.com  
Phone: (650) 703-1113  
Please let her know ahead of time, your coming. Free doughnuts & coffee for participants, is planned

**November 11, 2017** The Three Rivers Historical Society & Museum is having our annual living history day this year we are honoring our service members and veterans. The event is for one day running from 10am to 4pm.  
Thomas Marshall, Ph 559-561-2707  
www.3rmuseum.org

**October 21, 2017** To: All Interested Automobile Collectors. Auto Swap Meet At the Alameda Naval Air Museum. Sponsored by the Early Ford V8 Club & Alameda Naval Air Museum. 6:00 a.m. to 3:00 p.m. Large two car spaces, Stall price \$30.00, One car for sale space, \$20.00.  
All Show Cars or Military Vehicles, Preferred Parking in front of the Museum stairs. Bring a Show Car or Military Vehicle and get a Free Museum entry. All other Museum entry Special day price \$5.00.  
No Buyer charge for Swap Meet or parking. Early morning donuts and coffee available \$ 1.00 each, all proceeds go to support Alameda Naval Air Museum. Food Truck available after 9:00 a.m.  
For Information , Please call Larry, A.N.A.M at 510-522-6440 or Mark at 510-432-1532  
For mail in Entry Forms, Contact Alameda Naval Air Museum at , 510-522-4262.  
Starting next week , Entry Forms can be picked up at Lee Auto Supply on Park St in Alameda.



## MVCC NEWS STAFF



**MVCC Editor Dave Ball**

(408) 805-0065 [vought@msn.com](mailto:vought@msn.com)

Please submit all contributions for publication in the newsletter by email to the editor by the 15 of the month.



**Webmaster Sean Nichols**

[Jetnoise400@hotmail.com](mailto:Jetnoise400@hotmail.com)

[www.mvccnews.net](http://www.mvccnews.net)

(775)-424-3813

# MVCC STAFF



Dave Porter, Northern Region VP  
Divisions 530 & 916  
dnporter56@comcast.net  
530-677-5115



Kim Sievert, South Bay VP  
(408) 253-9469  
[vaudevillian@msn.com](mailto:vaudevillian@msn.com)  
Divisions 408, 669 North 650

Greetings from the North,  
As I write this we're about to get very busy with Military Vehicle events. Capital Airshow at Mather Airport in Rancho Cordova is first up on September 9th and 10th (Saturday and Sunday), then it's Camp Gridley at the Butte County Fairgrounds in Gridley on September 12th through 17th, then the MVCC Fall Meet at Tower Park on September 19th through 24th. I plan to attend all three of the September events. Camp Gridley is expanded this year with vendors and road trips and a living history display. Tower Park should be interesting with the new Jellystone Park theme. I wonder if

Yogi will visit us in our camping area... he should probably utilize a body guard or ride in an armored vehicle if he ventures into the "military zone". I've been spending a lot of time getting my DUKW ready for the NRG Flotilla at Camp Gridley. It will not be fully restored but hopefully it will be operational by that time. The big beast is not easy to work on, especially by yourself. They're just so darn BIG. Seems like every time I climb up the ladder and into the thing to work on it, I discover I need another tool or a different size bolt and have to climb back down, get whatever it is I need, then climb back in again. Good exercise I guess...

Hope to see you at one or all of the September events.

Dave



East Bay VP Mike Rinehart  
Divisions 510, 925  
[michaelwrinehart@sbcglobal.net](mailto:michaelwrinehart@sbcglobal.net)  
510-522-6440



Scott Rohrs, North. Bay West VP  
Divisions 707 & 415 west  
415-259-8177  
[recon3rdid@yahoo.com](mailto:recon3rdid@yahoo.com)

Things are still in flux right now for me, but I foresee calmer days are ahead, so I can get back to,,,, writing monthly news letter columns,,,,, back to working on my vehicles that I'm keeping and selling off vehicles I do not have time for,,,, back to start selling off stuff that I will never use. Here are some forth coming events in the South S.F. Bay area. Veterans Day Parade, in San Jose, on November 11th (see event listing for details or email me) Additionally there is a Veterans Day Static military vehicle request, for a Redwood City event on November 11th (see events listing for details). With fall and winter rains coming and some holidays being close by, give thought to buying enclosures or tarps for your vehicles / parts stored outside. Most online places will be offering free shipping and bargains on holidays. Old fart input on selling / camping at Camp Petaluma in 2017. Yes 2017, was not a good year to sell stuff at Camp Petaluma. But for a brand new location, that could be expected. I can see folks awaiting feedback of Camp Petaluma 2017, before going to Camp Petaluma 2018. Low attendance of visitors / buyers has always happened every time we have gone to new locations for camping,,,, aka,,,, Big Bear, Tower Park, Woodsen's Bridge 1 (CA state park) Woodsen's Bridge 2 (private camp ground), Casa De Fruita, Camp Robert's, Battery Alexander (GGNRA), Gridley, etc,,,,, all had more visitors / buyers, after the first camp out. The same was true of merchants bringing stuff to sell. Did you know that the Woodsen's Bridge campouts, were never initially planned, to be a swap meet ! On the subject of sites that our group has been to, there is also the subject of exploring new sites to visit. If you know of any places, give a scouting report to our President.

KIM

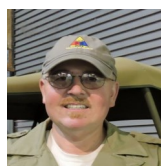

Don Gomes, Central Valley VP  
Divisions 209,559,661,760  
(209)765-1273  
[caddymanwestside@yahoo.com](mailto:caddymanwestside@yahoo.com)

# MVCC STAFF



Jack Valenti, Central Coast VP  
Divisions 831, 805 408 south  
LRDG@PRODIGY.NET  
831-595-3487

I have had a busy July and it looks like August may be just as busy or even busier.

We did the Monterey 4th of July Parade, with my trusty sidekick Marc Goldman and for a return engagement "Rob Albanese" who has returned to the Monterey Peninsula. We are looking forward to having him join us for future local events.

We quickly followed that up by attending the "Car Show" at Reid-Hillview Airport along with T-8 and a half dozen LRDG clad supporters. Also there; was the group from Eagle Field, providing Tank rides for quite a number of folks.

I left my jeep and trailer with Doug Boales as he wanted to take it to (along with T-8) to the Saratoga Car Show, which was on the 16th of July. I unfortunately was unable to attend as we were invited to some friends 50th Wedding Anniversary. Not sure which but one of the vehicles won the "Most Fun Award" at the Saratoga event. He is currently storing the vehicles in a hangar at Reid-Hillview airport.

Coming up, but will be over by the time this is published is the "Spirit of 45" at Kelly Park in San Jose on Aug 4th & 5th. All of the LRDG vehicles will be there (T-8 & T-9 along with my jeep). I'll be there on Friday to help them set up but Donna has other plans for Sat. So they had to do without me on Sat. But there was again a bunch of LRDG groupies in attendance.

Also locally starting on Aug. 13th on the Monterey Peninsula is the famous "Car Week", finishing up with the Pebble Beach Concourse de Elegance. They have added more auctions for that week and some interesting events. I have entered the jeep in the Pacific Grove Auto Rally on Friday the 18th. Last time I entered (2013) Damon Viola beat me out of an award with his truck. Time before that (2012) we did receive the "Young Judges Award" sponsored by Hagerty.

The day after that (Aug 19th) I've been invited by Phil Tracy to an event in San Jose but will be unable to attend because of a Monterey Bay Aquarium event on the same day.

I have nothing on my local schedule in September until the "Camp Delta" meet. If you know of something let me know.

Jack

SMITH CHEVROLET CADILLAC  
6<sup>th</sup> Annual  
Honoring Our Veterans Golf Tournament  
Benefiting the  
**TURLOCK VETERANS  
CHARITABLE TRUST**  
Friday, November 10<sup>th</sup>, 2017  
at Turlock Golf & Country Club  
9:00 Registration • 11:00 Shot Gun Start  
Food & Beverages Provided Throughout  
the Tournament. Heavy Hors d'oeuvres  
& Raffle Immediately Following 4 Person Scramble  
**\$135 Per Player**  
Prepaid by Oct. 15<sup>th</sup>  
(\$150 per player after)  
*Sponsor Opportunities Available.*  
*Sign Up Your Team Today!*  
Call for availability (209) 613-7352  
Mail and make checks payable to:  
"Turlock Veterans Charitable Trust"  
2930 Geer Rd. #154, Turlock CA 95382



Sonny Hanson, No. Bay, East VP  
(707) 552-6918 Div. 707,415  
[sonnyhanson@comcast.net](mailto:sonnyhanson@comcast.net)

Hello to you all. It's that time again to get ready to go to Tower Park, only it's called something else. I am not going to go on Monday, I will go on Wednesday that will make it four nights and save \$200.

I like Petaluma better. Had a good July 4th Parade, over 5000 people came out to celebrate, and got 1st place with the M135. I am looking forward to Fleet week at the Red Oak Victory Ship in Richmond. Google it. [www.Redoakvictory.org](http://www.Redoakvictory.org). A PBR and a Huey will be there giving rides. Tour the ship. Fun for the whole family. I will be there. Hope to see you there.

Sonny Hanson  
Your MVCC North Bay VP east  
From my non-mobile command center

# **THE GATHERING OF VIETNAM VETERANS TRANSPORTATION CORPS**

**10-15 SEP 2017**

**Inn of Morro Bay  
60 State Park Rd.  
Morro Bay, CA 93442  
805-772-5651**

Special rate for those who book under "The Gathering"  
All are welcome to stop by and visit!

**Contacts:**

**Kathy Blackstone: 936-239-3006**

**Barbara Bower: 757-814-3007**



**ABOVE IS A REPLICA OF THE SNOOPY 2 VIETNAM GUN TRUCK  
BUILT BY THE STAFF OF THE ESTRELLA WARBIRDS MUSEUM IN PASO ROBLES, CA.**

These armored trucks acted as security for convoys in Vietnam,  
delivering much need supplies including fuel to outlying Fire Bases  
over the dangerous passes in the mountain terrain.



Visit Online Store @ [www.rfjp.com](http://www.rfjp.com)

Ron Fitzpatrick

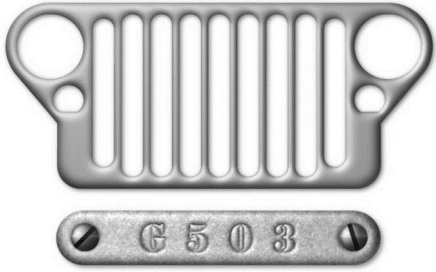

# JEEP PARTS

SEE OUR WEBSITE @ [www.rfjp.com](http://www.rfjp.com)



(541) 830-3030 (local) \* (541) 830-3031 (tech)  
sales@g503.com (541) 830-5337 (fax)  
M-F 8 a.m. till 5 p.m. West Coast

## 800-600-JEEP (5337)

*New not Rebuilt*



A1223 Carter WO  
Carburetor \$310



A8180 - LN Speedometer  
w/ trip odometer \$100  
MB or GPW

*Note: These have 1 mph incremented  
dials with the correct luminous paint on  
needles and the 10 mph and 20 mph  
markers*

Available markings  
GPW Ⓕ GPW8505  
or  
MB 637052



639992 Water Pump  
MB or GPW \$90



A8180 - SN Speedometer  
w/ trip odometer \$100  
MB or GPW

A8323 Fuel Pump  
w/ PrimerLever \$60



A847 or A838  
Tie Rod End Kits \$15



A1339  
Hub Puller \$15

GPW w/ script Ⓕ available

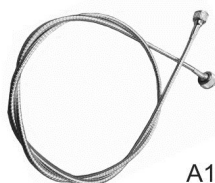

A1267 Speedometer Cable  
With metal Housing \$15

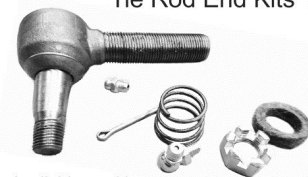

Available markings  
GPW Ⓕ  
or  
MB TP

*Each Kit includes cup, spring  
felt washer, cotter pin, castle  
nut and 2 zerk fittings*

# FREE SHIPPING\*

## Online Orders Only thru August 31st, 2017

\* restrictions apply: no phone orders, continental U.S. orders only,  
\$200 minimum order, oversized and freight orders excluded

Military Vehicle Collectors of California Merchandise



The 2017 MVCC Petaluma Meet Tshirt.

"Olive Drab"

This is a limited run Military Vehicle Event Tshirt, once they are gone they are gone! Sizes S,M,L,XL, XXL

Email or text for sizes still available!

\$20.00

The 2017 MVCC Petaluma Meet Tshirt

"Kaki" color...

\$20,00

These are limited, check for sizes



Limited Run 40th Anniversary MVCC Patch. This is a 4 inch patch, looks great, I bought 2 myself!

\$7.00 each



Limited Run 25th Anniversary MVCC Patch

This is a 4 inch patch, looks Awesome!

\$4.00 each



MVCC Patch

3 1/2 tall

\$3.00 each

This MVCC magnate is perfect for those who aren't sure they want a perminate sticker on their cars or military vehicles!



MVCC magnate

3 inch tall

\$2.00 each

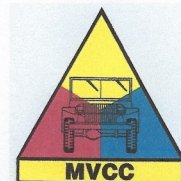

MVCC sticker

3 inch tall

\$2.00 each

MVCC Stickers are a GREAT WAY to show everyone you are a MVCC Member, put them on your military vehicles or your automobiles!



MVCC sticker

2 inch tall

\$1.00

For availability email [istanbull@sbcglobal.net](mailto:istanbull@sbcglobal.net) or text (209)918-0488

Mail payment to Christina Verissimo  
Treasure MVCC  
850 Elm Ave  
Gustine, Ca. 95322

The MVCC Antenna Guidon/Pennant is still available \$25.00. These are great for your flag pole or your military vehicle antenna!

These little stickers are great for car windows, tool boxes, gas cans etc...

Shipping; Give us your zip code and we will give you a shipping cost.

We don't have a Quartermaster yet so Don Gomes and Myself (Johnny Verissimo) are filling in as best we can, thank you for your patients...!



# CAMP ROBERT'S MUSEUM DAY

**SATURDAY, SEPTEMBER 23**  
**2:00 TO 6:00 PM**

**A PATRIOTIC TRIBUTE TO OUR MILITARY**  
**AT SCULPTERRA WINERY**

Enjoy military displays and booths, Army vehicles, Color Guard, live music by MONTE MILLS and the Lucky Horseshoe Band, patriotic addresses by civic and military leaders, classic and vintage cars, silent auctions & raffle prizes, premiere wine tasting, free giveaways, and more surprises! Delicious hot Santa Maria-style barbecue beef sandwiches and soft drinks available. **FREE ADMISSION!**



**RIDE THE CHINESE ANTI-AIRCRAFT GUN!**

**A Big Salute to  
Our Troops &  
Veterans!**

**A Patriotic Day to  
Coincide with  
Patriots Day,  
Constitution Day,  
and POW  
Recognition Day!**

**Music & Dancing!**

**Fun for All Ages!**

**Show Your  
Support for our  
Local Military!**

**SCULPTERRA WINERY  
& SCULPTURE  
GARDEN**

5015 Linne Road  
Paso Robles, CA 93446

(805) 226-8881

[WWW.SCULPTERRA.COM](http://WWW.SCULPTERRA.COM)

# MVCC BUSINESS MEMBERS

*Ron Fitzpatrick*  
**JEEP PARTS**



1022 Newland Road  
 Central Point, Oregon 97502

sales: 800-600-5337  
 tech: 541-830-3030  
 fax: 541-830-5337

www.rfjp.com www.g503.com/parts

**RON FITZPATRICK**  
 sales@g503.com  
 ron@g503.com

★ ★ ★ ★ ★ ★ ★ ★

Dc Truck parts 541-772-8992

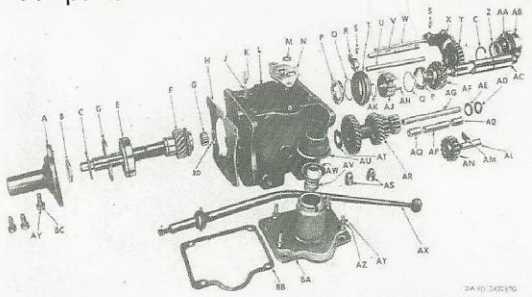

Dave Cirillo  
 dctruckparts@msn.com

**EXPEDITION IMPORTS**  
*Get Out of the Ordinary!*

Scott Ingham  
 President

scott@expedition-imports.com

www.mpttires.com  
 www.expedition-imports.com

1335 Lemon Street  
 Vallejo, CA 94590  
 Tel 707.643.6757  
 Cell 707.319.7252  
 Fax 707.643.2998

Ray Del Pino  DMV License #VV17807

ANTIQUE • CLASSIC • MODERN  
**VIN NUMBER VERIFICATION**  
 AT YOUR LOCATION IN SOUTHERN CA  
 TRUCKS, TRAILERS, SPECIAL MOBILE EQUIPMENT  
 MOTOR HOMES, AND CARS  
 DMV RUNNER SERVICE  
 CLASS C DRIVEAWAY - GETAWAY DRIVER  
 15708 E. Grovecenter St. • Covina, CA 91722  
 Cell: (626) 391-2167 • Home: (626) 814-2196

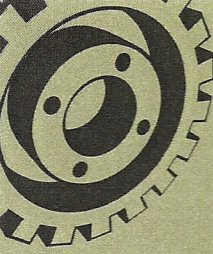

**DOWNTOWN TRUCK PARTS**

**NORMAN GORELICK**

20830 KINGSBURY ST  
 CHATSWORTH CA 91311

1-818-709-3676  
 MACK6X6@AOL.COM



**CARSON PLAINS SURPLUS & STORAGE**  
 Military Surplus, Military Vehicles, Storage, Firewood  
**JON BIRCHEFF**  
 Owner



P.O. Box 1289  
 70 S. Rainbow Dr  
 Dayton, NV 89403  
 Cell: 775-246-7186  
 Fax: 775-241-7142  
 jon.cpsands@gmail.com  
 www.cpsands.com

**Smith Chevrolet Cadillac, Inc.**  
*"Where service comes first since 1926"*  
 1601 Auto Mall Drive  
 Turlock, CA 95380



**Lee C. Smith**  
 Owner

(209) 632-3946  
 (209) 988-8832 Cell  
 (209) 667-7157 Fax  
 leesmith@SmithChevroletCadillac.com  
 smithchevroletcadillac.com



Find us on facebook.



**CAMP DELTA AT TOWER PARK  
FALL SWAP MEET  
SEPTEMBER 19-24, 2017  
14900 W. HIGHWAY 12, LODI, CA 95242  
TENTATIVE SCHEDULE**



**MVCC BUSINESS**

MVCC merchandise trailer/store/HQ Friday only, 10:30 to 4:00, by cabin # 170 near the campground exit ramp. If you missed getting the awesome Camp Petaluma shirt, they might have your size. Visit with our awesome Secretary and Treasurer. Renew early for 2018?

General Membership Meeting on FRIDAY at 10:00 a.m. by cabin #170. BRING YOUR CHAIR. All welcome. MVCC Officers introduced, news about Camp Petaluma 2018 and Fall 2017 events not already in the newsletter, and more!

Board Meeting is right after the Member Meeting

**GENERAL INFORMATION**

It's a MV gathering AND a swap meet! Clear out your shed! Sell the stuff you bought in April so you can buy more stuff! No charge to sell from your campsite. No vending in other places.

We are focused in Campground 2 this time, the one by the main levee road, NOT CG 4 where we used to be in the Fall. This puts us close to Rosa's Restaurant, bar, store, Sunset Sweets, and the marina and boat ramp.

Early birds welcome prior to Tuesday. Last Sunday is pull out day, not a show day

Day visitor fee for our commuters is waived. See parking section below.

Hotels are six miles east by Interstate 5. More lodging at B&W Resort, 5 miles west on Hwy 12.

There will be a fee and wristband to use the pools in Campground 4. Ask at office.

As usual, no fires on the ground because the peat soil will burn underground. Raised pits and wood are available.

If you are using a campsite you have used in the past, be aware they have installed paved patios and fire pits in some that can affect where you park or position a tent.

To make a camping or cabin reservation, contact our "Wagonmistress" Jo-Ann Lesser at [mamalesser@yahoo.com](mailto:mamalesser@yahoo.com) or 408-238-8277. She will assign you a site and will tell the reservation office to accept your deposit for it.

If you are bringing a MV but are not renting a campsite and have no place to park, usually someone has extra space in their site they will trade for beer, soda, or cash! Ask around or ask a MVCC officer, or contact John Neuenburg at [garage@hotmail.com](mailto:garage@hotmail.com) or 415-847-2801 or at space #148. Same goes if you have a site with extra room for a MV. John will try to put people together. To share a site for camping, Jo-Ann might know of someone.

**PARKING**

No parking in the campgrounds unless in your campsite. That includes along the roads in camp. Commuters use the levee which is very close, and walk in via stairs or ramp. Park on the campground side, not in front of the tenant boat sheds. No parking fee.

DO NOT STORE TRAILERS ON THE LEVEE! They use up space. Use the lot by the guard shack or frontage road shoulder.

Roads are fire lanes – do not block them. Do not park in a vacant campsite because it won't be vacant for long!

Management may have illegally parked vehicles towed to Lodi or Stockton

**ACTIVITIES**

- Morning Coffee and Treats, Cooper camp #147 north of the restrooms, Thursday-Saturday morning. MVCC fundraiser.
- CA State Military Reserve Historical Display, Saturday morning, LTC George Cooper's campsite #147.
- Lady's Social tentative for Friday 2 p.m. – watch our website for info and see the event flyer.
- If anybody wants to list a MV driving excursion, group trip to town, or campsite display in the flyer that will be handed out at the office and posted, contact John at [garage@hotmail.com](mailto:garage@hotmail.com) or 415-847-2801 cell, ideally before 9/13.

MV displays need to be in campsites although it might be OK to stage for photos in the Campground 4 field. Another good location is on the levee by the far gate.

# CLASSIFIEDS

**For Sale:** U.S. Military Jeep Radio Sets. MB/GPW: SCR-510 (BC-620), SCR-284 (BC-654), and SCR-610 (BC-659). M38, M38A1, M422/A1: GRC-7 (RT-68+R110+ RT-70), PRC-10, VRC-10 (RT-68), and VRC-18 (RT-68+R110). M151/A1/A2: VRC-53 (PRC-25) Complete and ready to install. Includes: Transmitter/Receiver, Power Supply (s), Radio/Power Supply Connector (s), Auxiliary Receiver (if applicable), Vehicular Shock Mount, Weather Cover (if applicable), Loudspeaker and/or handset, Antenna Mast Base Bracket, Antenna Mast Base, Antenna Sections, Vehicular Power Cable, and Antenna Cable. U.S. Military Man-pack Radio Sets. WW2: SCR-536 (BC-611), SCR-300 (BC-1000), SCR-510 (BC-620), SCR-284 (BC-654), and SCR-610 (BC-659). Korea: PRC-6, PRC-10, TRC-20/RT111/(BC-659). Vietnam: PRC-25. Including (where applicable) : Handset, Carrying Harness, Both Antennas, Accessory Belt Pouch, and Power Cable and Hand Crank Generator. U.S. Military Telephone Sets. WW2: BD-71 Field Telephone Switchboard with 6 EE-8 Field Telephones and Spool of Communication Wire, EE-8 Field Telephone, and TP-9 Field Telephone. Vietnam: Spool 2 Line Communication Wire. U.S. Military Fixed Radio Sets. WW2: SCR-520 (BC-659). Including Transmitter/Receiver, RA-120 110V Power Supply, MD-22/URA11 Modulator, Microphone, and Loudspeaker. Korea: RT-68. Including Transmitter/Receiver, PP-1175A/SR 110V Power Supply, Handset, and Loudspeaker.

Chuck Heindell, 530-282-6297,

Or email: cazamel@hotmail.com. 9-17

**For Sale:** MB/GPW original fuel tank. Has gone through the Gas Tank Renu process.

\$350.00 OBO

Matt (408)398-0036 or msira36@aol.com 8-17

**For Sale:** 1943 GTBS with crane and winches and both are frozen and engine is civilian flat head six .. also have parts from other GTBS's for sale ..asking \$2200 OBO For truck & crane Don . 209-765-1273 or email for me photos caddymanwestside@yahoo.com 11-17

**For Sale:** 1942 Dodge WC-24 1/2 Command Car w/ winch Older restoration, parade ready New NOS 1960's M601 "export" 230cid motor Older Beachwood top & doors 5 new Firestone 7.50 x 16 ND Military tires Calif. historical vehicle registration Was featured vehicle at Pearl Harbor's 50th. ceremonies in 1991 Attended 2003 MVPA convention, USS Hornet, Alameda. CA Attended 2016 MVPA convention, Pleasanton, CA Featured in "Standard Catalog of U.S. Military Vehicles 1940-1965" For more information, contact: Gerald Bowen 650-355-8052 gerald-bowen@comcast.net 11-17

**For Sale.** Three radio set , 24 volt, w/mounting bracket. All in good cond. may be from Korean war ? \$550.00 can deliver at tower Park. 4 Post car lift , made by Universal Bench Co. In working order when I got it from a Transmission shop. it's On my flatbed trailer ready for delivering or you pick-up. Alameda. Have fork lift on my end. \$1,300. OBO POC Sieg Wroebe 510- 316-3130 8-17

**For Sale:** Fiberglass Hardtop for Dodge M-37. \$450 Top came off Air Force M37 and is currently painted Blue. Has one piece non moving rear window in good condition. One 2" crack in a front corner that's easy to repair. Told this top will fit other M-Series vehicles. Top will need to be picked up in Napa. For more info call Peter Berendsen (707) 256-3894 or email peterber@sbcglobal.net 8-17

**Classified Ads** are free for military vehicle related items and kit for MVCC members. Your ad will run for three issues. Your editor will only except ads in writing. Please submit your ad by email: vought@msn.com or by post to: MVCC Editor: 18549 Paseo Tierra St. Saratoga Ca. 95070. Please print clearly and include contact info and price. Please submit ads by the 15th of the month. If you want to make changes to your ad including extending or cancelling your ad, you must notify your editor in writing. The MVCC is not responsible for omission's or Incorrect wording and or spelling. The MVCC reserves the right to edit ad copy for space. Please send payment for paid ads to: LK Viola, Email: sec-treasurer@mvcnews.net

**Ad prices: full page \$45 Half page \$35 Quarter Page \$20 Business Card \$5 per issue**

# CLASSIFIEDS

**For Sale:** M-151-A2 (MUTT) Barn Fined, ROP's Kit Installed - has all webbing, Great tires, body uncut, New Electrical harness front and rear, All fluids flushes, New hoses, new fuel sending unit, Starts up right away, New batteries, All seats and covers, Current registration, Heater kit installed, New exhaust system, Antenna mount corner bracket with antenna base, most new Gauges, Great find. Picture Below. \$17,500  
Brad Carrott (831)345-0372  
Bradcarrott@gmail.com

9-17



**For Sale:** 1977 Dodge M880: 4 wheel drive, rebuilt larger dodge engine w/ 4 barrel carb, upgraded muffler system, heavy duty truck tires, shock absorbers, over load springs and sway bar, electric winch, CUCV grill guard, power steering, spot light, black out lights, siren, roof rack, mounted tow bar, reupholstered seats, antenna mount, and power supply for PRC 25/77 radio. This truck is in excellent condition. It has just been serviced and has a new CA smog certificate. A comfortable military vehicle with lots of power. Call Chuck Billings 415 717-9904 or e-mail drcrbillings @comcast.net. 11-17

**Wanted:** Looking for a spare tire carrier for a Burma Jeep Cargo Truck. Please call Paul Lubker, (209)403-6261 8-17

**Wanted:** Parts for RT-524, Radio Remotes (2), Radio Control C-2299/VRC, 524-Radio Control Cable CX-4723U, Antenna Wire CG-3855/VRC. POC- Sonny Hanson 707-552-6918 or Bob Taylor 707-953-7242 11-17

**Wanted:** Looking for a Restored 1941 Dodge WC 1 I'm too old to do another Restoration, Looking for maybe an older restored truck that needs an appreciative home Contact: Tom Furrer email: uacg@sonic.net Phone: 707-481-2264 9-17

**Wanted:** WWII M-8 Armored Car in good running condition. Please contact Steve K at 714-299-4593 in Chino Hills, California 9-17

**Wanted:** M-345 10-ton 2 axle trailer in good Condition. These trailers were made in the 1960's and 1970's. Contact Jay 707-495-1871 pmmkin@hotmail.com 9-17

**Wanted :** US Navy sailor tunic from WW I era or earlier, Scout Car in running Cond. , Half-track in running cond. , Or any M-20 Greyhound in western states. Side curtains for My 1941 Command car Dodge, or just the metal frames. Any items from 49th. inf. Div. Calif. national Guard. Flags, banners, Uniforms, Helmets, Vehicles etc. WW2 glider in any condition. Wooden Ben Hur trailer from WW II. WW I and WW2 Recruiting posters.... suitable for framing. Harley -Davidson' WLA ' 1942 military style Motorcycle , VW "Thing", will Trade for VW Rabbit convertible, 1980 running, WW2 WACO glider, any cond. for Museum. U S Navy sailors uniform, EM or officer, Dress blues or dress whites from WW I or earlier. WW2 " Captains Gig", any cond. modified, in need of restoration is OK, they are 36 Ft. LOA. WW2 landing craft any length etc. POC Sieg Wroebel 510-316-3130 after 6 PM is best...Alameda 8-17

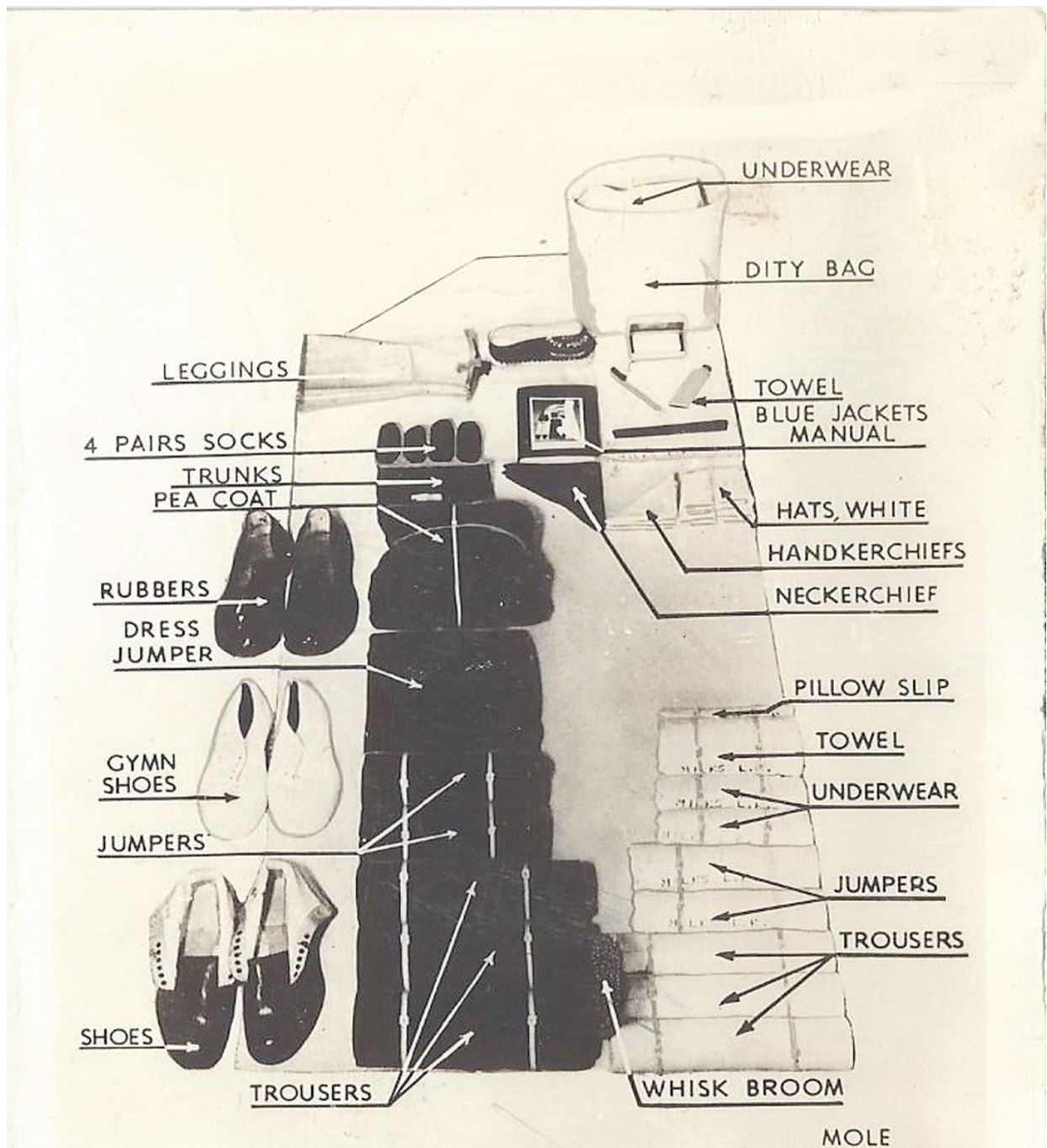

*Bag Lay-out*  
 U. S. NAVAL TRAINING STATION  
 GREAT LAKES, ILLINOIS

MOLE

Small card found being used as a book mark. It belonged to my father in-law, Glenn Sievert. Glenn passed on February 4, 2017. He was a WW2 Veteran and served in the Navy on Guam 1944-1945. He went through boot and communications training at Great Lakes. ED.



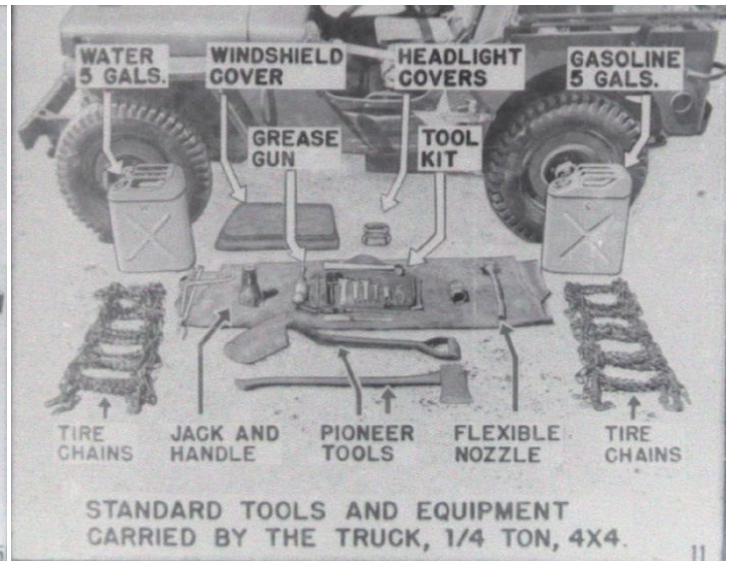
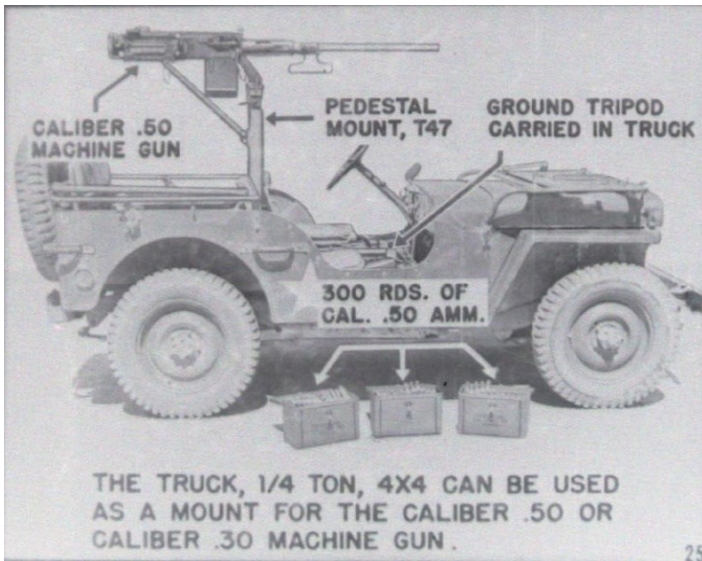

Three pictures showing the 1/4 ton truck found in an old book are pretty self explanatory.

ED.



**Military Vehicle Collectors of California**  
*Dedicated to the acquisition, restoration, preservation, safe operation,  
 Public education and display of historic military transport*

**WE WANT YOU**  
**TO JOIN / RENEW**  
**YOUR**  
**MVCC**  
**MEMBERSHIP!**



**INVOICE**

Life Members should disregard this notice. THANK YOU for your support! If you have already renewed, THANK YOU! please check the date code on your newsletter mailing label and membership card. Is your expiration year "2017" ?

If it is this means your membership expires January 1, 2017. Please renew your membership.

**Please enter an e-mail address for possible future methods of communication.** If you list MV's or related hobby interest, it will show up on membership lists the MVCC Officers receive. Sometimes we want to contact members with certain MV's about displays or movie work. Note that you may opt-out of having contact or hobby information published in the next Member Directory booklet. This is your application. Separate it from the newsletter, or copy it, fill it out, and fold it put it in an envelope with your check inside, apply postage, and mail it. Simple!

\* = required fields, please PRINT

\*Name \_\_\_\_\_ MVPA # if applicable \_\_\_\_\_

\*Address 1 \_\_\_\_\_

Address 2 \_\_\_\_\_

\*City, State, ZIP \_\_\_\_\_ Country \_\_\_\_\_

Home phone \_\_\_\_\_ Cell phone \_\_\_\_\_

E-mail address \_\_\_\_\_

\*I DO / DO NOT want my contact information in the Directory (circle one)  
 List military vehicles you own (year, make, model) and/or related hobby for the next Directory. Help those with similar interests find you. Use separate sheet if necessary.

\_\_\_\_\_

\_\_\_\_\_

\_\_\_\_\_

\_\_\_\_\_

\_\_\_\_\_

**MEMBERSHIP (check one)**

Term is Jan 1 – Dec 31

- \$35 regular member for one year only newsletter mailed
- \$85 regular member for three years newsletter mailed
- \$25 regular member for one year only newsletter online only
- \$60 regular member for three years newsletter online only
- \$60 business member (includes one, 2"x 3.5" ad in each newsletter (business card). No voting rights. A business member may also hold another class of membership

**ASSOCIATE MEMBERS** (spouse or significant other, and/or children under 18).

Includes membership card. Only spouse has voting rights.

One newsletter delivered per household

\_\_\_\_\_ Associates @ \$5.00 each per year, badge \$12.50

New members receive one badge. Associate Badges and replacement badges \$12.50 ea.

Amount enclosed \_\_\_\_\_

Print associate name and relationship to member

\_\_\_\_\_

\_\_\_\_\_

\_\_\_\_\_

Christina Verissimo, c/o MVCC Treasurer,  
 850 Elm Street Gustine, Ca 95322  
 Make checks payable to the MVCC

\*I DO / DO NOT want my MVs or hobby interests listed in the next Directory (circle one)