

the CALIFORNIA **MV** Collector 
NEWSLETTER

EDITOR: DAVE BALL

February 2019

VOL. XLII

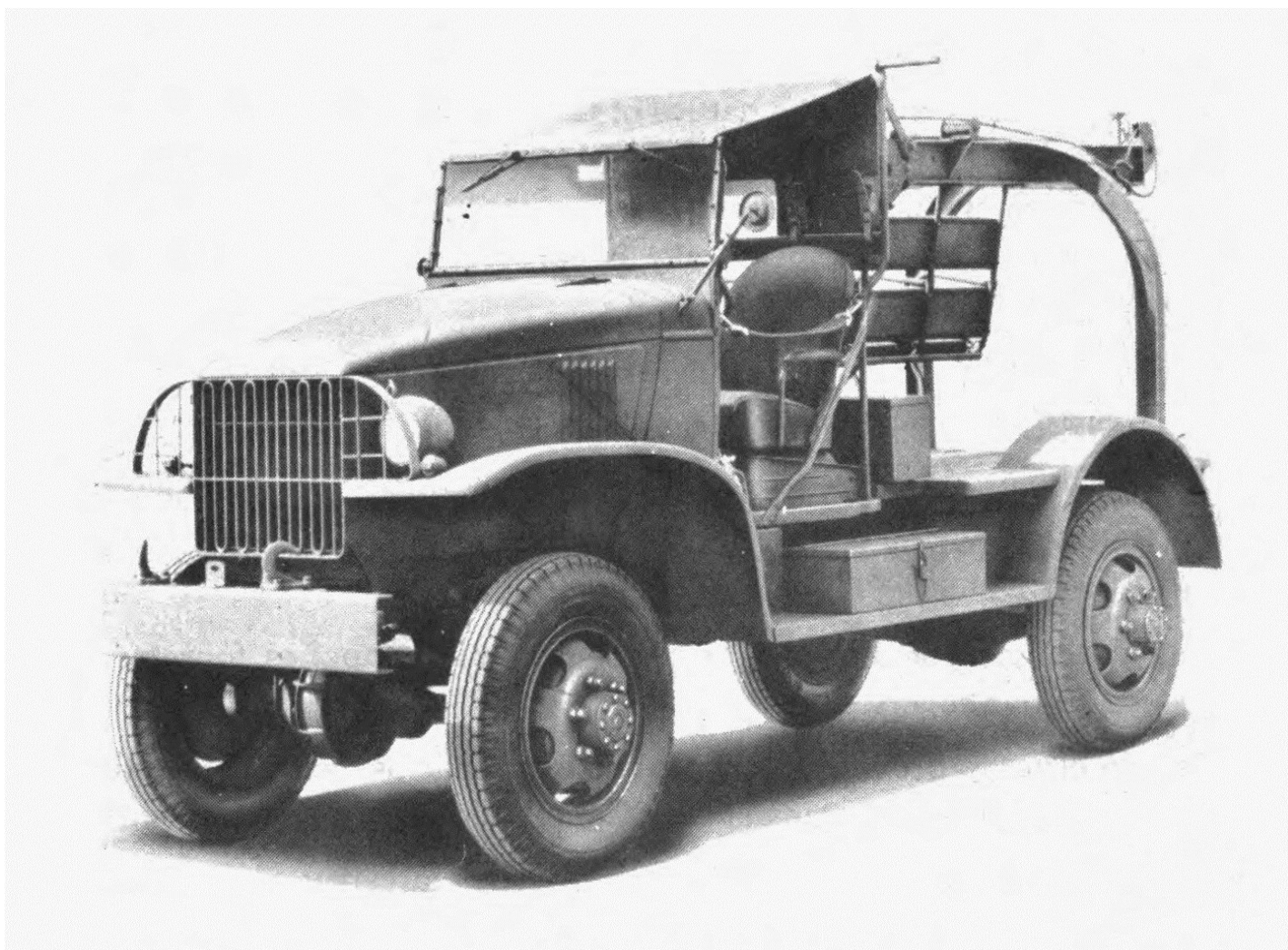

Bomb Service Truck M6 (Chevrolet 4x4). Used to load, unload and tow bomb trailers. Powered by a overhead valve six cylinder engine. Four speed non synchronized transmission and a 2 speed transfer case. Has an open cab with two bucket type seats and rear platform on which a hoist is mounted for loading and unloading bomb trailers.

ED

MVCC BUSINESS MEMBERS

Brad Smardo
I Pay CASH For Military Items

Smardo-Militaria

No Item Too Small or Too Large
Cell (916) 521-6221
bsmardo@hotmail.com

Uniforms, Medals, Guns, Paperwork, Rifles
Patches, Helmets, Flags, Knives, Pictures
Field Gear, Pins, Badges, Hats, Swords, Caps



ANGUS SMITH
Vice President of the Board
Cell: (831) 240-5311
AngusJSmith@Frontier.com

GENERAL PATTON MEMORIAL MUSEUM

62510 CHIRIACO ROAD
CHIRIACO SUMMIT, CALIFORNIA 92201
www.GeneralPattonMuseum.com

DOWNTOWN TRUCK PARTS



NORMAN GORELICK

20830 KINGSBURY ST
CHATSWORTH CA 91311

1-818-709-3676

MACK6X6@AOL.COM

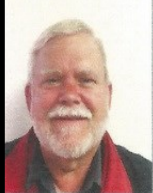

*"Where service comes
first since 1926"*

**Smith Chevrolet
Cadillac, Inc.**
1601 Auto Mall Drive
Turlock, CA 95380

Lee C. Smith
Owner

(209) 632-3946
(209) 988-8832 Cell
(209) 667-7157 Fax
leesmith@SmithChevroletCadillac.com



smithchevroletcadillac.com



MIDWEST MILITARY, INC.

www.midwestmil.com



PARTS & TRUCKS
BUY • SELL • TRADE • RESTORE
REPRODUCTION SHEETMETAL

JOHN BIZAL

Phone 952-440-8778 • Fax 952-440-8776
16075 Hwy. 13 South, Prior Lake, MN 55372

Central Oregon Surplus LLC

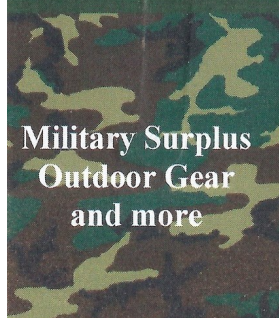

Kyle Vanderhoef

**Military Surplus
Outdoor Gear
and more**

PO Box 1371
Redmond, OR 97756
541-548-0946

kylev@centraloregonsurplus.com
www.centraloregonsurplus.com

NEW AND IMPROVED MD JUAN Vintage Restoration Parts

- Based on authentic and original measurements
- Well fitted
- Easy to install
- Ed coated - rust resistant
- Tested for almost 52 years



MD JUAN

UPCOMING EVENTS

February 15th- 17th 2019 21st Annual Vintage 4wd Winter Expedition Out of Somerset, Ca. Dry Camping avail. Contact for info Ryan Shelly (925) 395-1100

March 9, 2019 24 hours of Lemons race at Sonoma Raceway. The MVCC has been invited to show our Military Vehicles in the paddock area and to take some laps around the track. Camping overnight. <https://24hoursoflemons.com/>
For info contact: John Neuenburg 415-847-2801 or in_garage@hotmail.com

April 3-7 2019 2nd SoCal MVCC annual rally and swap meet. The Soledad Rally has been moved to Lake Piru for more information visit www.scmvcc.com contact Richard Johnson for reservations and information (619)993-5284 or Email: killroy321@hotmail.com
www.camplakepiru.com

April 12-14 2019 Antique Tractor and Truck Show, Tulare, CA. Premier event with dry camping for RVs, great food and flushing toilets. contact Gary Hanes at margiandgary@charter.net for details.

April 16-21, 2019 Military Vehicle Collectors of California annual Spring swapmeet, campout and military vehicle rally. Held at our new location in Plymouth Ca. **49er village RV resort and Amador County Fairgrounds**. No vendor or visitor fee except camping fee. Lots of Free parking for day use. Contact: MVCC Wagonmistress Joann Lesser 408-238-8277 or 408-440-6068 email mvcccampmistress@yahoo.com

MAY 24-26 2019 4th Annual "BEST of the WEST" antique tractor, truck, MV Show/Warbird Fly In. Santa Margarita Ranch located on US 101 between Atascadero and San Luis Obispo.. Entry forms @ www.thebestofthewestshow.net. Contact Gary Hanes with questions at margiandgary@charter.net.

June 15, 2019 Eagle Field Fly In Dinner, Dance and Military Vehicle Event. Onsite camping, bathrooms and showers. POC is Don Gomes (209)765-1273 caddymanwestside@yahoo.com

JULY 20, 2019 Annual "Central California Cooler" presented by ATHS in NIPOMO, CA on US 101 between San Luis Obispo and Santa Maria. Antique trucks from pickups to 18 wheelers. Show is at Nipomo High School on Saturday, setup on Friday. Overnight bivouac. Contact: Gary Hanes at margiandgary@charter.net

September 11-15 2019: Camp Gridley Butte County Fairgrounds, Hosted by the NRG www.northernrecongroun.org

September 18-23, 2019
MVCC Fall swapmeet
Second largest annual Military Vehicle gathering and swap meet in the West.
Location TBD...



Kim Sievert, South Bay VP
(408) 253-9469
vaudevillian@msn.com
Divisions 408, 669 North 650



Jack Valenti, Central Coast VP
Divisions 831, 805 408 south
LRDG@PRODIGY.NET
831-595-3487

AT THE FRONT



Dave Ball, MVCC President
(408) 805-0065
vought@msn.com

Hello Everyone:

I hope everyone is dry and warm and that the wind did not rip all of your tarps to shreds. While going through the multitude of articles and various flyers sent to the editor I came to the conclusion that if you cant find the info you need to get a campsite at Camp Plymouth its not because of lack of information. In this jam packed newsletter you will find all the info you need to get a campsite and have a great time. The Camp Plymouth venue has something for everyone. Remember to spread the word that there is plenty of free parking. Also the tent sites are really very reasonable for those of you that are weekend warriors. This year we will have many things to cram into our days at Camp Plymouth. The foothills around Plymouth and Highway 49 are full of backroads and gold rush towns. If you are staying in a tent site please plan to bring a pop up canopy or a tarp. Camo nets work great for sunshade but if we get some rain (like usual) camo netting will not keep you or your parts dry. Please read the newsletter carefully and if you have any questions you can always call Johnny or myself.

This is an Election Year so if you would like to nominate yourself or a friend talk to Johnny or Myself. Remember all positions are always on the ballot available for nomination. New People bring New Ideas!!!

“Keep ’em Rolling, Floating and Flying”

Dave Ball

President and Editor

Military Vehicle Collectors California



Andy Shyers East Bay VP
Divisions 510, 925
510-832-4322
mvcc510925@gmail.com



Dave Porter, Northern Region VP
Divisions 530 & 916
dnporter56@comcast.net
530-677-5115

MVCC FRONT OFFICE

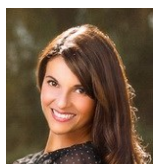

Christina Verissimo, Treasurer
(209) 918-0388
crstna_vrsmo@yahoo.com



John Verissimo, Secretary
(209) 918-0488
istanbull@sbcglobal.net

Camp Plymouth Event Flyer is Available to You

The event flyer printed in this newsletter is available to you via email. Just ask an MVCC officer for the PDF file. Please help us get the word out about this event and new location. Print some and walk into your favorite auto parts or military surplus store, museum, or local veteran's center with a flyer and some tape and thumb tacks in your pocket and ask the manager to help us tell people about something interesting. Those of you in the Highway 50 and 99 corridors and in the foothills can help get the word out to unaffiliated MV owners and fans who are an easy drive or tow away. Many don't know about the MVCC or our annual events. We finally have room for a lot of new faces!

Hagerty to Sponsor the Camp Plymouth Truck Showcase

One of the two themed vehicle showcases planned for Friday April 19 will be Ford GTBs and Chevrolet M6 Bomb Service Trucks Presented by Hagerty. POC Don Gomes reports that it is time for the GTB series of trucks to get their place in the sun. Rumors are out there that some trucks never seen at our big meets will show up. Could our display set a Western U.S. record? It is also time to throw a bone to the rare Chevy bomb truck owners. One reason they are being included is that they are so rare it would be tough to have an impressive display all by themselves. Another reason is there will be at least one GTB bomb truck there, so the Chevy and Ford designs can be compared side-by-side. Great idea Don!

This showcase will include a People's Choice Contest with cash prizes courtesy of Hagerty Collector Vehicle Insurance. YOU get to vote for your favorite! Hagerty provides insurance to the MVCC and is the insurer for many of the classic MVs we will see in Plymouth. They have also sponsored awards at many Military Vehicle Preservation Association National Conventions and the Youth Judging Programs at each. This program was started in 2007 and they host these for children ages 8 to 14 at over 100 classic car and boat shows throughout the U.S., Canada, and the UK. Young judges are guided through a group of pre-selected vehicles to learn details, history, and fun facts about each. A simplified score card is used. They offer a kit for car show promoters who want to incorporate youth judging at their show. This is part of the Hagerty Youth Advocacy Program, along with Hagerty Test Garage and Hagerty Driving Program for young adults.

Hagerty representative Joe Giuntini will be camping most likely in RV site 34 and will have information about insurance, their new Hagerty Driver's Club which has evolved from the Hagerty Plus Roadside Assistance product, and the youth programs mentioned above. For information see www.Hagerty.com.

WAGON MISTRESS REPORT, CAMP PLYMOUTH, APRIL 16 – APRIL 20, 2019

Jo-Ann Lesser 408.238.8277

Can you believe it, we are only 3 months away from our Spring camp out and swap at 49'er RV Resort. If you have been assigned a site now is the time to get your deposit paid. Having a deposit guarantees that the site you picked will be awaiting your arrival. If there is no deposit on a site by **March 1, 2019**, it will be considered available and will be assigned to the person at the top of the wait list. The 49'er can be reached at 209.245.6981.

If, you have contacted me for a tent site at the Amador County Fairgrounds please remember that these sites must be paid in full prior to arrival. I do not want to be responsible for collecting camp fees during the meet. The daily rate for tent camping is \$25. Multiply the daily rate by the number of nights camping and mail payment to MVCC Treasurer, 850 Elm Street, Gustine, CA 95322.

At this time, there are no cottages available at the RV park but, I do have a wait list in case of cancellations as well as a wait list for electrical/water tent sites at the fairgrounds. If this list is something you would like your name on please let me know.

I can be reached at mvcccampmistress@yahoo.com or 408..238.8277

MVCC STAFF



Don Gomes, Central Valley VP
Divisions 209,559,661,760
(209)765-1273
caddymanwestside@yahoo.com

Hello to all MVCC members

I hope all is well in your neck of the woods and please don't forget to pay your dues to keep your newsletter delivered on time. Well back to my Froggy story the restoration of my Ford GTBS Bomb service truck . Now the truck has been totally disassembled and painted now it's time to put Froggy back together . So now the new Firestone tires were mounted on all four corners then set back on the ground . Next was the engine! she ran like a top so I just resealed it and the trans and transfer case as well then set them back in the frame . Next was to put the dash in and windshield frame then front fenders, steps, grill, inner glass, bumper and side tool box . Then it was time to set the bed on rear fenders and bolt it all down with the original bolts washers and nuts .After the bed was bolted down and rear bed cap we set the crane and winches on . So note that this single rear wheel GTBS did not have rear bumperettes from the factory . The next job on Froggy was to paint all the lettering and hood numbers so Johnny V ordered decal stencils from the UK about a month before we needed them . Next we set all stencils on all panels and painted them in a satin white then removed all stencils WOW we were done with the paint !!Don't forget the GTB & M6 Show Case at Camp Plymouth in April !! Stay tuned for my next installment .

MVCC Central Valley V.P Don Gomes
Keeping History Alive !!



Scott Rohrs, North. Bay VP
Divisions 707 & 415 west
415-259-8177
recon3rdid@yahoo.com

Hello North Bay West and beyond,

Happy New Year to the membership! As we start the new year I have been approached by Sonny Hansen (former North Bay East VP) to take over his responsibilities as VP of that area. I accepted until we have another election. I will now have the whole of the North Bay Area (707 & 415 area codes). I would like to thank him for his years of service to the membership and the board. I still look forward to visiting with him at further events. As always, if you have events that you want published, call or e-mail me.

I would like to endorse an event that I have enjoyed in the past. That is Member Ryan Shelly's Vintage 4wd Winter Expedition. This event is February 15th -17th. He holds this event at his family cabin out of Somerset. This is a great weekend driving forest roads in the snow. There is dry camping at his cabin and a lot of pre 1975 4wd rigs (civilian & military). Bring your chains! Contact Ryan at (925) 395-1100

Scott Rohrs
North Bay VP

MVCC SECRETARY, JOHNNY VERISSIMO

Good Morning MVCC Members!

Its getting to be that time year. Planning is in FULL swing for the 2019 MVCC Military Vehicle Show and Swap Meet in Plymouth California! ... Actually we started working on Camp Plymouth the same week we left Camp Petaluma. Putting on an Event like this takes at least a year in preparation. I'm very happy to say we are going to Camp Plymouth. Location Location Location is everything and this new place has Location!

Again I am looking for volunteers to help at the MVCC HQ Booth Thursday, Friday and Saturday! The booth will be open from 10AM to 5PM all 3 days. This year I am doing something **NEW**, for every 2 hour shift you do at the MVCC HQ you will get a ticket for a drawing to win a \$50 gift certificate to the MVCC HQ Store! Yes, All MVCC Booth volunteers who put in a 2 hour shift get a ticket, if you put in 2 shifts you get 2 tickets. This is only for MVCC HQ Booth volunteers!

MVCC Headquarters/Merchandise Booth/Dues HQ is at site 188 & 189. Please stop by and say Hello! And maybe even buy something?!! Pay your dues, Or drop off a raffle item you would like to donate to help support your MVCC. We will have some raffle items on display throughout the event.

If you would like to put your name down for a shift please call me at (209)918-0488 or send me an email at istanbull@sbcglobal.net. \$50 goes a long way at the MVCC HQ Merchandise Booth!!!

I'm really looking forward to this new venue! It has free parking, it has free admittance, free parking for car trailers, it has room to drive your MV's, it has room to grow and grow!

I look forward to seeing everyone in April! Meanwhile get your vehicles or sales items ready!

Johnny Verissimo

MVCC Secretary

istanbull@sbcglobal.net

(209)918-0488

www.mvccnews.net



MVCC NEWS STAFF



MVCC Editor Dave Ball

(408) 805-0065 vought@msn.com

Please submit all contributions for the newsletter by email to the editor by the 15 of the month.



Webmaster Sean Nichols

Jetnoise400@hotmail.com

www.mvccnews.net

(775)-424-3813

If you have any questions or have information regarding a meet or activity in your area, contact your regional vice president or any of the officers to let them know. Be sure to visit our website for any last minute activities or changes to activities/events. Please submit information regarding upcoming activities to the newsletter editor at least two months before the scheduled event. All articles must be submitted to the newsletter editor by the 15th of each month.

MVCC News Editor Dave Ball vought@msn.com

www.mvccnews.net

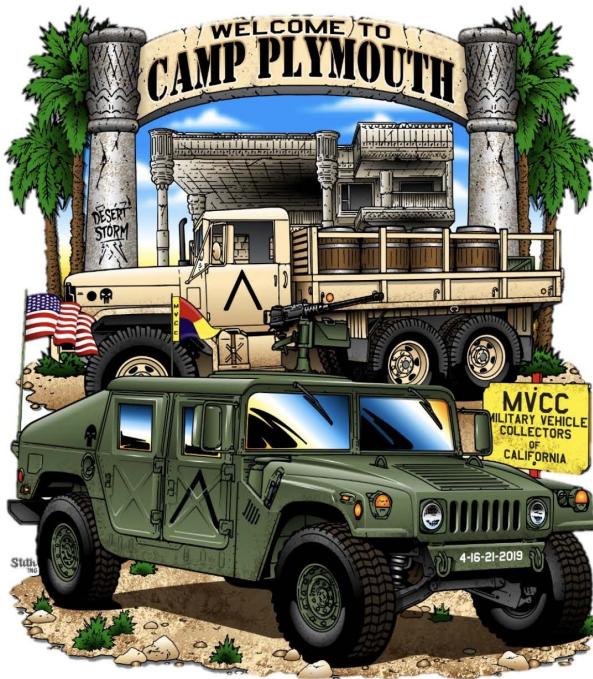

MILITARY VEHICLE COLLECTORS OF CALIFORNIA

CAMP PLYMOUTH

42ND ANNUAL SWAP MEET & MILITARY VEHICLE DISPLAY

PRESENTED BY MD JUAN

*The Largest Annual
Historic Military Vehicle Event in the West!*

April 16-21*, 2019

Plymouth, California

Replaces the Tower Park and Petaluma Venues

All privately owned, former military vehicles welcome, any condition, NO vehicle registration fee

Parts & military collectibles swap meet for professionals & amateurs. NO seller fee but sellers must rent a campsite or cabin. Clean out your garage!

FREE admission. Friday Open House

FREE visitor parking at Amador County Fairgrounds Reserved military vehicle parking and "for sale" area

Military Vehicle Poker Rally on scenic area roads

Raffle Friday including a MD JUAN Ford Script Maxi-Kit!

Two themed military vehicle showcases on Friday with People's Choice Contests, cash awards - display yours!



**Jeep Showcase: WWII, Korea
Vietnam, CJ pre-1987
presented by MD JUAN**



**Ford GTB & Chevy M6 Bomb
Service Truck Showcase
presented by Hagerty**

NEW VENUE FOR THE SPRING MEET!

RV or travel trailer camping, cabins, at 49er RV Village, discounts for MVCC members, see www.MVCCNews.net for member info

Inexpensive tent camping at the Hagerty Tent Sector at adjacent Amador County Fairgrounds with gate connecting to the RV Village

Facilities at 49er RV Village for campers include pool, spa, clubhouse, laundry, store, café, play facilities, fishing

Visit 42 Amador County wineries & historic Gold Country towns

* Early arrivals OK. Sunday is a pull out day, not a show day

For all camping contact Jo-Ann, 408-238-8277 or email MVCCCampmistress@yahoo.com, NOT the 49er office

Event info: visit the MVCC website or contact Don, 209-765-1273 or caddymanwestside@yahoo.com

VEHICLES , PARTS, MILITARIA

BUY, SELL, SHOW, DRIVE

*49er RV Village, 18265 Hwy 49 and Amador County Fairgrounds
Plymouth, California 95669*

WWW.MVCCNEWS.NET





EIGHTEENTH ANNUAL DODGE POWER WAGON RALLY

SAVE *the* DATE

JUNE 21st - 23rd 2019, Hollister Hills - California

Woody's

WOODY'S GOLF & INDUSTRIAL
VEHICLES

Chris Dias

Sales, Parts, Rentals & Service

Authorized Dealer



The #1 Golf Car
in the World!

P.O. Box 1628
Turlock, CA 95381
2900 E. Monte Vista Ave. fax 209-667-9032
woodyscarts@yahoo.com

209-634-2948

800-624-6091

Woody's
MANUFACTURING

Dick Dias

2900 E. Monte Vista Ave. P.O. Box 1628 Turlock, CA 95381

209-634-2948 FAX 667-9032 800-624-6091

Manufacturers of Quality Custom Metal Products

Daily Briefing

Camp Plymouth Presented by MD Juan – 16-21 April 2019

ALL WEEK – Swap Meet is open! Please check campsites through the 49'er RV Campground AND the Hagerty Tent Sector at the Fairgrounds next door for an amazing selection of items. Vendors MUST be in rented campsites, cabins or official tent spaces. Tickets will also be sold during the week for the special raffle prize of a 1942 Ford Script Maxi Kit donated by MD Juan!

Tuesday, April 16

Swap Meet Begins!!

1800 – EARLY BIRD POTLUCK DINNER. Rec Hall. Bring your utensils, plate, food to share. POC – Jo-Ann Lesser/Cabin #5

Wednesday, April 17

Swap Meet Continues!!

1300-1600 – WINE WEDNESDAY CONVOY. Meet at 1245 in parking lot of the Pokerville Market across the street with your MV to convoy to select Shenandoah wineries. POC – Jennifer Tanis / Swamp

Thursday, April 18

Swap Meet Continues!!

0700 until coffee's gone - Early Morning Coffee. Location: Hagerty Tent Sector with specific site to be announced later.

1000 - POKER RALLY CONVOY. Meet @0930 in the Parking Lot of the Pokerville Market across the street from the campgrounds. Register at the table outside the market to receive your driving orders. First vehicle goes out at 10. Price is \$5 per poker hand, maximum of 1 hand per person. (Money taken in will be returned in the form of prizes to people with the 3 best poker hands.) - POC – Dave Porter (Northern CA VP) 530-391-8006 / Swamp

1000 – 1600 – MVCC HQ/Store Open at Sites #188 & 189, near the Rec Hall. JOIN OR RENEW, meet MVCC officers, see who is camping where, drop off raffle items, buy the GREAT MVCC Commemorative memorabilia. Support the MVCC!

1400 – WOMEN OF THE MVCC GATHERING. Rec Hall. Special guest speaker from Native Daughters of the Golden West. Bring any food you'd like to share and BYOB – Bring Your Own Beverage

1600 – MVCC Board Meeting – Location to be determined.

1700 – 1900 - BARBECUE DINNER ONSITE. Near the Rec Hall. Price and Menu to be announced later.

Friday, April 19

Swap Meet Continues!!

0700 until coffee's gone - Early Morning Coffee. Location: Hagerty Tent Sector with specific site to be announced later.

0900 – WOMEN'S OFFSITE BRUNCH AND SHOPPING EXPEDITION. Meet @ 0845 near the front entrance by the Rec Hall. We will be heading to a local restaurant for brunch, then have time for some boutique and antique shopping in the historic Gold County. All welcome; need drivers. POC – Nancy Porter (530-391-5650 or Nancy@ForkInTheRoadTravel.com)

1000-1700 – COMMUNITY DAY. Although the public can visit any day, this time is being advertised as a special open house time for the public to come see the showcases, demos, shop and find out about our hobby.

0930 – 1100 – JEEP SHOWCASE Sponsored by MD Juan. Location: Arena at the front of the Hagerty Tent Sector

1000 – 1600 – MVCC HQ/Store Open at Sites #188 & 189. Near the Rec Hall. JOIN OR RENEW, meet MVCC officers, see who is camping where, drop off raffle items, buy the GREAT MVCC Commemorative memorabilia. Support the MVCC!

1300-1600 – FORD GTB & CHEVY M6 TRUCK SHOWCASE Sponsored by Hagerty Insurance. Location: Arena at the front of the Hagerty Tent Sector

1700 – BARBECUE DINNER & RAFFLE. REC HALL. Price and Menu for dinner to be announced later.

Saturday, April 20

Swap Meet Continues!!

0700 until coffee's gone - Early Morning Coffee. Location: Hagerty Tent Sector with specific site to be announced later.

1000 – MVCC GENERAL MEMBERSHIP MEETING. Location to be announced.

After General Meeting to 1600 – MVCC HQ/Store Open at Sites #188 & 189, near the Rec Hall. JOIN OR RENEW, meet MVCC officers, see who is camping where, buy the GREAT MVCC Commemorative memorabilia. Support the MVCC!

1300 – 1500 – Convoy to a local historic location

Sunday, April 21 - There will be a community Easter Egg Hunt in the morning at the 49'er Campground.

The Un-Official Guide to Places to Stay near Camp Plymouth

This list is not comprehensive and provides a variety of places to stay near Camp Plymouth. Of course, we recommend staying at Camp Plymouth (the 49'er RV Park or next door in the tent camping area). If you prefer a hotel, here is a suggested list. We haven't tried all of these but they seem to have good reviews. And, please know that this list does NOT guarantee that the hotels have availability. Pricing varies depending on how many rooms are available, whether you're staying on a weekday or on the weekend.

If you want to use the reservation services offered by our travel agent at no additional cost, please feel free to contact Nancy Porter at Nancy@ForkInTheRoadTravel.com or 530-391-5650.

Plymouth

Shenandoah Inn. A couple blocks from Camp Plymouth. Small, older hotel with spacious rooms and a good view from the large windows. Parking lot. Very close and some MVCC members have reservations there already.

Plymouth House Inn. Bed and breakfast on Main Street in downtown Plymouth. Being on Main Street, parking is limited to lots to the back and side streets.

Rest – A Boutique Hotel. Also on Main Street. Parking is limited.

Amador City – About 9 minutes from Camp Plymouth. Small town popular with antique hunters.

Imperial Hotel. B&B - An 1879 brick hotel turned into a B&B. Full breakfast, saloon and on-site restaurant. Parking limited.

lone – About 13 minutes from Camp Plymouth.

lone Hotel. – Renovated hotel that reflects its history of the early 1900's. Free wireless. Bar and restaurant on the property.

Jackson – 15 to 20 minutes from Camp Plymouth, right on Hwy 49. Downtown is a Historic Gold Rush town with narrow streets and quaint shops. Outside downtown, there's lots of shopping, restaurants and reasonably-priced chain hotels. Walmart and the hospital are also in Jackson.

Best Western Amador Inn. Free internet, parking and breakfast. On Hwy. 49. They have some pet-friendly rooms (extra charges apply). Rooms have refrigerator, microwave, coffee/tea maker, etc.

Holiday Inn Express & Suites. Free internet, parking and breakfast. On Hwy. 49. Rooms have refrigerator, microwave, coffee maker, etc.

National Hotel. An old, historic renovated hotel originally built in 1862. This historic hotel is in the middle of downtown, which can be fairly congested. Parking for hotel guests, but there might not be room for trailer parking.

Jackson Lodge. This small hotel site has 28 hotel rooms and 8 guest cabins. Wi-fi and breakfast NOT included. Each room has a coffee maker, TV, blow dryer and basic amenities.

Jackson Rancheria. Casino and Hotel 20 minutes (14.5 miles) from Camp Plymouth. This place is east of Jackson, between Jackson and Sutter Creek. Lots of parking. Buffet onsite in addition to gambling and entertainment.

Sutter Creek – Historic Gold Rush town about 13 minutes from Camp Plymouth

Hotel Sutter. This historic hotel sits in the middle of downtown Sutter Creek. Free wi-fi but parking is limited to side streets. There is a restaurant and 2 bars onsite as well as other nearby restaurants.

Grey Gables Bed & Breakfast. This is a beautiful old house in Sutter Creek with luxurious guest rooms and a full breakfast. Parking is limited.

Hanford House Inn. There are 16 guest rooms in this location and it's at one end of downtown Sutter Creek. Unlike most B&B's, the atmosphere here is modern and the breakfast is at the Elements restaurant next door.

020219 - FITRT

Camp Plymouth Swap Meet & Military Vehicle Show April 16-21, 2019
Presented by MD JUAN

This meet could be our biggest one in 42 years! It solves the challenges we faced at Petaluma KOA and the new ones at Tower Park. We have almost unlimited, free, visitor and commuter parking onsite, and these people can easily pick up and deliver parts and MVs. Admission is free. There are plenty of RV sites with room to grow, and over 140 inexpensive tent sites. We have a fenced arena for vehicle showcases. Plymouth is a short distance from the center of the state and major north-south and east-west freeways. Like Petaluma there are scenic MV driving roads with interesting tourist destinations. For more details, check out the event flyer in this issue.

WIN A MD JUAN SCRIPT FORD JEEP MAXI-KIT AT CAMP PLYMOUTH!

We have a title sponsor for this upcoming show! It seems like some companies have been paying attention to the number and type of people we attract and want to give us their message. The reproduction jeep parts manufacturer MD Juan is our primary sponsor. They are known for their wartime and postwar jeep body tubs, plus most other parts bolted to them besides engine, drivetrain, instruments and electrics. At the event they will display parts and information about their manufacturing facility. MD Juan is also the sponsor of the People's Choice Contest cash prizes for the "Jeep Showcase - WWII, Korea, Vietnam, CJ pre-1987 Presented by MD Juan." See information about that elsewhere. Help us set a Western U.S. military jeep display record! Bring your jeep, Mite, MUTT, or CJ, in any condition!

The biggest part of the sponsorship fee paid by MD Juan is a trade. President Rommel Juan has given the MVCC a Maxi-Kit as is shown on the adjacent page. Of the several wartime MB and GPW kits they offer, the Board chose their early Ford Script model. This will arrive looking like the fabled "jeep-in-a-crate" and will be on display at the event. This kit will be sold to a lucky winner at the annual fundraising raffle on Friday evening! The anticipated revenue helps the Board budget money for the event and for the benefit of members. How would this kit look as-is in YOUR man cave garage?



MD JUAN JEEP MAXI-KIT

PARTS INCLUDED	
1. Tub - Body	46. Assy. - Gun Rack
2. Assy. - Windshield	47. Assy. - Lock, Toolbox with H700 Keys
3. Assy. - Fender RHLH	48. Assy. - Bracket, Oil Can
4. Assy. - Hood	49. Assy. - Housing, Headlight
5. Assy. - Grille	50. Assy. - Housing Blackout, Tail & Stoplight
6. Assy. Clamp Windshield (Clamp & Hook)	51. Kit - Reflector
7. Weatherstrip - Windshield Frame to Cowl	52. Kit - Bracket, Fire Extinguisher
8. Weatherstrip - Windshield Inner Frame	53. Filler - Front Bumper
9. Bumper - Windshield, Hood Top	54. Bracket - Support, Air Cleaner RHLH
10. Socket - Pivot, Top Bow	55. Holder - Lube Guide Envelope
11. Clamp - Ax, Front & Rear	56. Tire - Non-Directional
12. Clamp - Ax, Rear	57. Assy. - Spilt Rim
13. Bracket - Strap Safety Swivel	58. Boot - Transmission/Transercase Rubber
14. Handle - Body Outside, Rear	59. Hook - Rear Seat
15. Handle - Body Outside, Front	60. Assy. - Bracket Grease Gun
16. Loop - Footman	61. Set - Plate, Data, Dashboard (Series 1)
17. Bracket - Shovel	62. Assy. - Surge Tank Bl
18. Bracket - Front Hand Rail RHLH	63. Battery - J Bolt
19. Ring - Transfer Case, Boot	64. Assy. - Bracket Oil Filter
20. Ring - Transmission, Boot	65. Assy. - Gas Tank, Big Spout
21. Bolt - Wing Windshield	66. Assy. - Shield Splash
22. Bracket - Pivot, Top Bow	67. Assy. - Muffler, Oval
23. Bracket - Antenna	68. Assy. - Exhaust Pipe, Flexible
24. Bracket - Blackout Drive Lamp	69. Strainer - Gas Tank
25. Housing - Blackout Drive Lamp	70. Assy. - Spring Leaf Front & Rear
26. Assy. - Bracket, Headlight RHLH	71. Boot - Transfer Case, Rubber
27. Assy. - Catch, Hold Down, Hood	72. Assy. - Pedal, Accelerator
28. Assy. - Catch, Hold Down, Windshield	73. Pad - Pedal, Clutch
29. Assy. - Arm, Mirror, Side View	74. Pad - Pedal, Brake
30. Assy. - Shield, Master Cylinder	75. Assy. - Tray, Battery
31. Assy. - Strap, Hold Down, Fuel Tank Outer	76. Strap - Battery Hold Down To Fender
32. Assy. - Strap, Hold Down, Fuel Tank Inner	77. Assy. - Frame, Battery Hold Down
33. Gusset Toe Board RHLH	78. Horn - Air Cleaner
34. Carrier - Spare Tire (3 Studs)	79. Bracket w/ Crankcase Ventilator Connector
35. Assy. - Rest, Foot, Rear Floor	80. Chassis
36. Plate - Skid, Exhaust Pipe Guard	81. Filler - Front Bumper
37. Assy. - Frame Seat, Driver	82. Rope - Bumper Front
38. Assy. - Frame Seat, Passenger	83. Assy. - Radiator with Shroud
39. Assy. - Frame Seat, Rear	84. Assy. - Windscreen Wiper Arm & Blade
40. Carrier - Can Spare Gasoline	85. Seat Cushion (Driver, Passenger & Rear)
41. Bracket - Strap Guide, Jerry Can Carrier	86. Plate - Crush Pad
42. Exhaust Mounting Kit	87. Bracket Horn
43. Bumperete - Rear	88. Spartan Horn with Bracket (6V)
44. Support Spare Tire Carrier	89. Canvas Top
45. Plate - Spare Tire	90. Top Bow



MVCC BUSINESS MEMBERS



Department of California
DAV
Established 1921

ANDREW MOJARRAS
JR. VICE COMMANDER
2017-2018

P.O. Box 1872
TURLOCK, CA 95380

(209) 712-8572
andrewcadav@gmail.com
www.davcal.org

FULFILLING OUR PROMISES
TO THE MEN AND WOMEN WHO SERVED

Dc Truck parts 541-772-8992

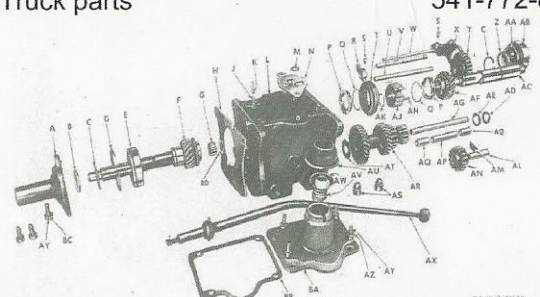

Dave Cirillo
dctruckparts@msn.com

EXPEDITION IMPORTS

Get Out of the Ordinary!

Scott Ingham
President

scott@expedition-imports.com
www.mpttires.com
www.expedition-imports.com

1335 Lemon Street
Vallejo, CA 94590
Tel 707.643.6757
Cell 707.319.7252
Fax 707.643.2998

Ray Del Pino  **DMV License #VV17807**

ANTIQUE • CLASSIC • MODERN
VIN NUMBER VERIFICATION
AT YOUR LOCATION IN SOUTHERN CA
TRUCKS, TRAILERS, SPECIAL MOBILE EQUIPMENT
MOTOR HOMES, AND CARS
DMV RUNNER SERVICE
CLASS C DRIVEAWAY - GETAWAY DRIVER
15708 E. Grovecenter St. • Covina, CA 91722
Cell: (626) 391-2167 • Home: (626) 814-2196

JAY'S WWII JEEPS

Specializing in vintage WWII Willys MB/Ford GPW vehicles and parts

1-844-WW2-JEEP



Jay Hinton | Napa, California USA | 1-844-992-5337 | jay@jaysww2jeeps.com



CARSON PLAINS SURPLUS & STORAGE
Military Surplus, Military Vehicles, Storage, Firewood

JON BIRCHEFF
Owner



P.O. Box 1289
70 S. Rainbow Dr
Dayton, NV 89403
Cell: 775-246-7186
Fax: 775-241-7142
jon.cpsands@gmail.com
www.cpsands.com

California Cars AB, USA
prlubker@gmail.com



Paul Lubker Cell 209.403.6261
754 Loquat Ave.
Patterson, CA 95363

Camp Plymouth – Not Just for the Guys

What's there for the women to at Camp Plymouth besides follow the guys around or sit back and relax? Here's a list of activities planned or available while we're in Plymouth:

Wineries – Plymouth's Shenandoah Valley is home to over 25 award-winning wineries. In fact, there are 40 wineries throughout Amador County. On Wednesday, we'll be visiting a few Shenandoah wineries on our Wine Wednesday convoy, but it can be fun to go back and visit even more another time. Most of the wineries are open from 10-11 am until 4-5 pm. Some don't have any tasting fees. Those that do charge a tasting fee will apply that amount toward the price of any wine purchased. This is the place to refill the wine rack at home and have wines for camp dinners!

Antiquing & Yard Sales – Gold Rush areas such as Plymouth, Sutter Creek, Jackson, Amador City, Drytown, Volcano and Fiddletown provide us with a huge number of antique stores. Friday and Saturday you might also find some great yard sales, too.

Women's Camp Gathering – Thursday @ 2 pm bring whatever you want to drink and possibly a snack to share with the other camp women at the Rec Hall. We'll chat and find out about hobbies, etc. This year there will be a guest speaker from Native Daughters of the Golden West, talking about their organization, its support of veterans and historic preservation, and their "home" in San Francisco designed by architect Julia Morgan (who also designed Hearst Castle).

Women's Off-Site Brunch – Friday morning join the carpool to go out to one of the historic towns for brunch and shopping. We'll start with brunch at one of the restaurants recommended by locals then explore the open shops and boutiques before being back at Camp around noon.

Daffodil Hill and Amador Flower Farm – World-famous Daffodil Hill is held every March/April in Volcano, about a half-hour drive from Camp Plymouth. Actual dates depend on the weather and other factors so we can't guarantee it will be open. (No pets allowed.) Gardeners also enjoy a visit to Amador Flower Farm, home of over 1,000 varieties of daylilies. See them and purchase some to take home.

Poker Rally Convoy – Thursday morning, bundle into an MV for a ride through the Amador County countryside. You will stop at designated points along the drive to pick up an envelope with a poker card sealed inside. Once back in camp, turn your envelopes into the collection desk in the Rec Hall, where they'll be opened and "Best Poker Hand" determined. Price is \$5 per hand with money collected being awarded to the 3 best hands. We need women to help with the morning registration as well as in opening and recording the poker cards each person draws. Even if you don't want to participate in the Rally, your help is overwhelmingly appreciated.

These are some of the major activities in the area that the women might be interested in. Please feel free to contact our Activities Chairman and resident Travel Agent – Nancy Porter if you have questions or want more details. Nancy@ForkInTheRoadTravel.com or 530-391-5650.

CLASSIFIEDS

FOR SALE: Dodge M37 parts inventory for sale as a lot on eBay – if you're interested in buying out my entire selection of remaining M37 parts – please check eBay. These parts will be available for pickup in Geyserville, CA or we may be able to arrange shipping if needed. Questions?
Richard Privat 707-484-8257 (call or text) or email rpironman@hotmail.com 3-19

FOR SALE: GMC 2-1/2 ton 6x6 & Chevrolet 1-1/2 ton 4x4 WWII parts inventory for sale as a lot on eBay – if you're interested in buying out my entire selection of remaining parts – please check eBay. These parts will be available for pickup in Geyserville, CA or we may be able to arrange shipping if needed. Questions? Richard Privat 707-484-8257 (call or text) or email rpironman@hotmail.com 3-19

FOR SALE: Two unrestored WWII Jeeps and two extra bodies. \$5,700 for all. Offers welcome. Located near Reno, NV. Pictures below. Call John for details at 775-690-8066. 2-19

FOR SALE: 1944 Ford M20 Armored Utility Car. This has been to our meets for a number of years. Street driven to 50 mph. Current CA registration. No brake issues, powerful. Many spares. Time to move on. \$73,000. Consider WWII jeep as partial trade. No show jeeps or real nice ones. Or partial trade for 28–30 foot flatbed trailer. Own the dream. John at 415-847-2801 or in_garage@hotmail.com. 2-19

WANTED: Early Dodge WC parts wanted to include; complete windshield assy., bucket seats, marble reflectors, blackout and taillight, wiring harness, tailgate, good tires.... 1898kma@gmail.com Calvin 3-19

FOR SALE: 1953 M38A1 USMC Jeep Willys Registered on a NON OP Radio RT68 NOS with mount and antenna 5 new rims and tires Recent minor body work and paint. Professionally relined gas tank, rebuilt generator, radiator, new clutch and resurfaced fly wheel, new break pads, Have photos before the breakdown and after. One complete Jeep and Enough other parts for almost another complete Jeep Includes: 1964 M416 Trailer. \$10,000. Jeep Trailer 1,500.00

For Sale: 1952 Dodge M43 Registered Historical plates \$4000.00 Raquel Lantz Rainwater Kern County 661-972-2742 2-19

FOR SALE: 1942 Chevy 1 1/2 ton G7116 Lots of work has been done to bring this Chevy back to its former glory, it runs, drives and stops like a champ. All the canvas is new and new tires all round. This truck is ready for the next parade. \$15,000 or best offer. Contact Darren Marshall 650 417 8813 2-19

FOR SALE: M-416, 1/4 ton trailer, Frame off sand blasted, all new electrical harnesses, new chain hooks, new lights, freshly painted Army green, New data plates, new drain plugs, Looks great!!! \$2300.00

FOR SALE: M-416, 1/4 ton trailer, perfect condition, rare top original military, every thing original, has 24 volt tail lights, and 12 volt lights. Absolute perfect. \$3200.00 firm. Pictures in newsletter issue #10 2-19
Brad Carrott
831 345-0372

WANTED: US WWII Small Wall Tent in good condition. John at 415-847-2801 or in_garage@hotmail.com 2-19

Classified Ads are free for military vehicle related items and kit for MVCC members. Your ad will run for three issues. Your editor will only except ads in writing. Please submit your ad by email: vought@msn.com or by post to: MVCC Editor: 18549 Paseo Tierra St. Saratoga Ca. 95070. Please print clearly and include contact info and price. Please submit ads by the 15th of the month. If you want to make changes to your ad including extending or cancelling your ad, you must notify your editor in writing. The MVCC is not responsible for omission's or Incorrect wording and or spelling. The MVCC reserves the right to edit ad copy for space. Please send payment for paid ads to: LK Viola, Email: sec-treasurer@mvcnews.net
Ad prices: full page \$45 Half page \$35 Quarter Page \$20 Business Card \$5 per issue

CLASSIFIEDS

WANTED: Chevrolet M1008 K30 1 ¼ Ton Military Truck in good original running condition from 1984 to 1987 – the later the better. Should have clear title and should be located in Central/Southern California. Herman Pfauter, Santa Barbara. Email HP2@WEST.NET, Telephone 805-964-9449.” 2-19

FOR SALE: M100 Trailer rough great for hauling parts to swap meets. \$450obo, Ben Hur wooden side rack with all metal brackets wood rough good for patterns . \$180obo WW2 antenna mount square swinging type . \$150obo Ford GTB battery box great condition . \$150 . 2 G506 or M6 , CCKW Chevy 20in rims blasted& primed \$250 obo . 1 M5 Bomb trailer rough condition parts maybe restore \$450 obo Also will trade for WW2 Bomb Ordnance equipment. Call or text Don 209-765-1273 2-19

FOR SALE: 1943 GTBS not running has good tires crane winches are frozen but in good shape also has civilian engine .. \$1700obo also have 1943 MBT trailer needs rust repair has Lunette hitch, brake handle , 1 original chain, Data plate and folding leg \$750.obo Don . 209-765-1273 Picture below 3-19



Idaho Motor Pool Museum Auction

Closing February 18, 2019 on line only
For more information see www.jbsauctions.com
There will be Jeeps, ¾ ton trucks, Display Guns, Military Radios & parts, Gun mounts, large Ordnance, Black Powder Cannon, lots of parts some WWII. Packing and shipping will be available. For more information call 208-452-5335 Alex Gordon 2-19

FOR SALE: 1952 GMC 2 1/2 ton truck, running \$4500, 195? M38A1 body \$400 (may have springs and axle to fit at extra cost), WWII M63 ground mount 50cal \$1250, all sorts of uniforms, naval items, helmets, and all the crap no one needs but everyone should have. Lee Edwards 925-447-9387 whenlde@aol.com 2-19

FOR SALE: Misc. Jeep Parts Military and CJ GPW fenders (rough) Axle Housings Generators 6v & 12V Springs Motors- 4cyl F head (running when pulled) 6cyl Willys Hurricane Engine (same) Bell Housings GPW and CJ GPW Radiator (core) and so much more! Call Scott 415 259 8177

FOR SALE: from a long time collector's estate, 500+ books covering all things military including uniforms, specific events, vehicles, some in German, also 140+ uniforms. Nothing too exciting but lots of wearable from WWII to current issue. Lee Edwards 925-447-9387 or whenlde@aol.com

MILITARY VEHICLE COLLECTORS of CALIFORNIA

JEEP SHOWCASE

PEOPLE'S CHOICE CONTEST

WWII - Korea - Vietnam - CJ Pre 1987

Presented by MD Juan

*Hosted
by:*

*In association
with:*

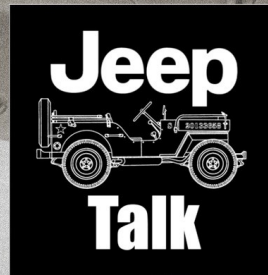

Amador County Fairgrounds, Plymouth CA

Friday 19 April 2019

 **MD JUAN**

For more information go to: www.mvccnews.net

Good Morning MVCC Members!

Its Official that MD Juan is the April 2019 MVCC Event Sponsor! And! MD Juan has donated a complete **MD Juan 1942 Ford Script Tub/Body Jeep Kit!** That's RIGHT, THE WHOLE KIT in a Box! A **\$7,000 VALUE** to the MVCC April Event raffle on April 19th at 6PM! I know it sounds crazy but its TRUE. You can buy your Jeep Raffle Tickets from myself, Johnny Verissimo (MVCC Secretary) or at the MVCC Booth at the *Camp Plymouth 42nd Annual Swap Meet & Military Vehicle Display this April!*

I have made 1,000 special MD Juan Jeep Raffle tickets. They will be sold at **\$5 each.** Buy as many tickets as you like. If you would like to see the kit just go to www.mdjuan.com . It's a jeep in a crate.

Proceeds from this raffle will help the MVCC to advertise its events more, buy office supplies, merchandise and help offset the costs of higher mailing costs just to mention a few.

This will be one of the coolest raffle prizes we will have in recent MVCC history. I guess you could say you need to be present to win because you will need to take it home after the raffle! Lol. Yes the MD Juan Kit will be on display at the MVCC HQ Booth during the April Event so come by and check it out!

If you have any questions please feel free to ask...

Johnny Verissimo

MVCC Secretary,

(209)918-0488

istanbull@sbcglobal.net

MVCC on FB

www.mvccnews.net,

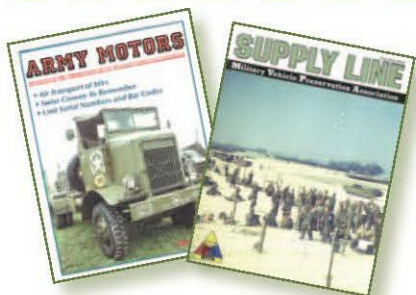

Military Vehicle Preservation Association

History In Motion

Since 1976 the Military Vehicle Preservation Association's mission is to provide an international organization for military vehicle enthusiasts, historians, preservationists and collectors interested in the acquisition, restoration, preservation, safe operation, public education and display of historic military transport.

All membership types include all MVPA Periodicals

U.S.A. MEMBERSHIPS

- Second Class Postage - \$50.00
- First Class Postage - \$75.00

MEMBERSHIPS OUTSIDE THE U.S.A.

- Canada Economy Air - \$60.00
- International Economy Air - \$70.00

OUTREACH SPONSORSHIP

- To US Organization or School
- Second Class Postage - \$50.00

Electronic Membership

- Worldwide E-Membership - \$35.00
- (Does not receive Printed Publications)

MVPA Recruiting Member _____ Membership Number: _____

Name of Applicant _____

Address _____

City _____ State _____ Zip _____

Telephone _____ E-mail Address _____

16 Digit Credit Card # _____

Exp. date _____ / _____ Signature _____

Complete this application and mail with a check or money order (on a U.S. bank in U.S. funds) to the address below.

MVPA ☉ PO Box 520378 ☉ Independence, MO 64052

Phone: (800) 365-5798 ☉ E-mail: hq@mvpa.org ☉ Fax: (816) 833-5115





Military Vehicle Collectors of California
*Dedicated to the acquisition, restoration, preservation, safe operation,
 Public education and display of historic military transport*

WE WANT YOU
TO JOIN / RENEW
YOUR
MVCC
MEMBERSHIP!



INVOICE

Life Members should disregard this notice. THANK YOU for your support! If you have already renewed, THANK YOU! please check the date code on your newsletter mailing label and membership card. Is your expiration year "2017" ?
 If it is this means your membership expires January 1, 2017. Please renew your membership.

Please enter an e-mail address for possible future methods of communication. If you list MV's or related hobby interest, it will show up on membership lists the MVCC Officers receive. Sometimes we want to contact members with certain MV's about displays or movie work. Note that you may opt-out of having contact or hobby information published in the next Member Directory booklet. This is your application. Separate it from the newsletter, or copy it, fill it out, and fold it put it in an envelope with your check inside, apply postage, and mail it. Simple!

* = required fields, please PRINT

*Name _____ MVPA # if applicable _____

*Address 1 _____

Address 2 _____

*City, State, ZIP _____ Country _____

Home phone _____ Cell phone _____

E-mail address _____

I DO / DO NOT want my contact information in the Directory (circle one)

List military vehicles you own (year, make, model) and/or related hobby for the next Directory. Help those with similar interests find you. Use separate sheet if necessary.

MEMBERSHIP (check one) Term is Jan 1 – Dec 31

\$35 regular member for one year only newsletter mailed

\$85 regular member for three years newsletter mailed

\$25 regular member for one year only newsletter online only

\$60 regular member for three years newsletter online only

\$60 business member (includes one, 2"x 3.5" ad in each newsletter (business card). No voting rights. A business member may also hold another class of membership

ASSOCIATE MEMBERS (spouse or significant other, and/or children under 18). Includes membership card. Only spouse has voting rights. One newsletter delivered per household

_____ Associates @ \$5.00 each per year, badge \$12.50

New members receive one badge. Associate Badges and replacement badges \$12.50 ea.

Amount enclosed _____

Print associate name and relationship to member

Christina Verissimo, c/o MVCC Treasurer,
 850 Elm Street Gustine, Ca 95322
 Make checks payable to the MVCC

*I DO / DO NOT want my MVs or hobby interests listed in the next Directory (circle one)